



# RESIDENTIAL USER GUIDE

---

## TECHNICAL DATA

For Joists, Headers, Beams,  
Rim Board, Columns, and Dimension

---

**PWT** FOCUSED ON EWP

## Welcome to PWT!

At PWT, we believe in quality over quantity. So our company's sole focus has been engineered wood products since 1998—no attempts to be something we're not. No distractions. Just a steadfast dedication to industry-leading innovation and the highest-quality EWP products. This targeted strategy means we're the only dedicated EWP manufacturer to offer whole-home solutions (indoors and out), which means you can rely on us to bring you the best.

Our customer's confidence in our products and service is our business's bedrock.

So you know you can count on PWT's superior EWP across our entire line.

Our 25-year warranty on exterior products, our application expertise, and elevated customer support back this trust.



**FOCUSED ON THE FOREFRONT OF ENVIRONMENTAL RESPONSIBILITY, SUSTAINABLY HARVESTED TIMBERLANDS, AND SUPERIOR PRODUCT INNOVATION, PWT™ IS AN INDUSTRY LEADER IN THE EWP SPACE.**



FOCUSED ON EWP

## Equivalency Chart\*

WOOD I-JOISTS				
	PWT†	Trus Joist	Boise	Roseburg
Solid Sawn Flange	PWI 18S	TJI 110	BCI 5000	RFPI 20
	PWI 20S	TJI 210	BCI 6000	RFPI 400
	PWI 32S	TJI 230	BCI 6500	RFPI 40
	PWI 42S	TJI 360	BCI 60	RFPI 70
LVL Flange	PWI 53L	TJI 230	BCI 6500	RFPI 40
	PWI 36L	TJI 360	BCI 60	RFPI 70
	PWI 56L	TJI 560	BCI 90	RFPI 90

STRUCTURAL COMPOSITE LUMBER				
BEAM / HEADER THICKNESS	PWT†	Trus Joist	Boise	Roseburg
1½"	LVL (1.6E 2250F <sub>b</sub> )	LSL (1.55E)	LVL (1.8E)	LVL (1.6E)
	LVL (2.0E 2900F <sub>b</sub> )	LVL (2.0E)	LVL (2.1E)	LVL (2.1E)
1¾"	LVL (2.0E 2900F <sub>b</sub> )	LSL (1.55E)	LVL (1.8E)	LVL (1.6E)
		LVL (2.0E)	LVL (2.1E)	LVL (2.1E)
3½"	LVL (2.1E 3100F <sub>b</sub> )	LSL (1.55E)	LVL (1.8E)	LVL (1.6E)
		PSL (2.0E / 2.2E)	LVL (2.1E)	LVL (2.1E)
5¼" - 7"	LVL (2.1E 3100F <sub>b</sub> )	PSL (2.0E / 2.2E)	LVL (2.1E)	LVL (2.1E)

RIM BOARD THICKNESS	PWT†	Trus Joist	Boise	Roseburg
1¼" - 1¾"	LVL Rim Board	LVL Rim Board	LVL Rim Board	LVL Rim Board

COLUMNS	PWT†	Trus Joist	Boise	Roseburg
Various Sizes	LVL	PSL	LVL	LVL

\* Please note: This equivalency chart is intended to provide a reference to similar strength / performance characteristics by respective manufacturers and is subject to change without notice. Please refer to manufacturer's website for the most current information.

† Code reports for Pacific Woodtech Corporation: I-joist ([ESR-1305](#), [ESR-1225](#)); LVL ([ESR-2909](#), [ESR-2403](#))

Not all products are available in all markets. Product substitutions are subject to a review by a design professional, which may include the project structural engineer.

FOCUSED ON EWP

## Product Warranty

Visit our website at [pwtewp.com](http://pwtewp.com) for a copy of our warranties.



# PWT I-Joist Dimensions

For more information about our complete line of products, visit [pwtewp.com](http://pwtewp.com).

## SOLID SAWN FLANGE

### PWI 18S

$\frac{3}{8}$ " OSB Web  
2 $\frac{1}{2}$ " x 1 $\frac{1}{2}$ " Flange

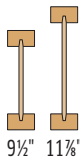

### PWI 20S & PWI 32S

$\frac{3}{8}$ " OSB Web  
2 $\frac{1}{2}$ " x 1 $\frac{1}{2}$ " Flange

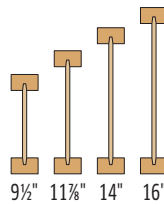

### PWI 42S

$\frac{3}{8}$ " OSB Web  
3 $\frac{1}{2}$ " x 1 $\frac{1}{2}$ " Flange

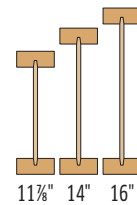

## LVL FLANGE

### PWI 53L

$\frac{3}{8}$ " OSB Web  
2 $\frac{1}{16}$ " x 1 $\frac{1}{16}$ " Flange

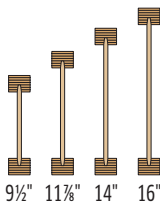

### PWI 36L

$\frac{3}{8}$ " OSB Web  
2 $\frac{1}{4}$ " x 1 $\frac{1}{2}$ " Flange

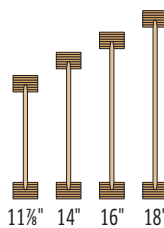

### PWI 56L

$\frac{7}{16}$ " OSB Web  
3 $\frac{1}{2}$ " x 1 $\frac{1}{2}$ " Flange

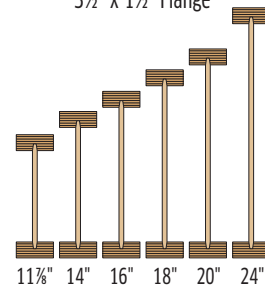

# Reference Design Values<sup>(1)</sup>

## Solid Sawn Flange I-Joists

Joist Series	Depth	Moment <sup>(2)</sup>	EI (x10 <sup>6</sup> ) (lb-in <sup>2</sup> )	Shear (lbs)	ER <sup>(3)</sup> (lb)	IR <sup>(4)</sup> (lb)	k (x10 <sup>6</sup> ) (lb-ft/in)	Vertical Load <sup>(5)</sup> (plf)	Weight (plf)
PWI 18S	9½"	2365	142	1130	882	1975	0.355	1900	2.6
	11½"	3100	248	1335	887	2095	0.435	1760	2.9
PWI 20S	9½"	2810	185	1260	984	2195	0.358	1900	2.6
	11½"	3755	318	1485	989	2330	0.438	1760	2.9
	14"	4400	474	1680	993	2455	0.512	1600	3.1
	16"	5050	652	1870	997	2570	0.582	1500	3.3
PWI 32S	9½"	3620	243	1260	984	2195	0.213	2200	2.6
	11½"	4690	406	1485	989	2330	0.267	2200	2.9
	14"	5645	589	1680	993	2455	0.313	1600	3.1
	16"	6545	791	1870	997	2570	0.358	1500	3.3
PWI 42S	11½"	6965	547	1625	1280	3025	0.515	2200	3.5
	14"	8390	802	1875	1329	3140	0.607	1600	3.8
	16"	9725	1092	2115	1374	3245	0.693	1500	4

## LVL Flange I-Joists

Joist Series	Depth	Moment <sup>(2)</sup>	EI (x10 <sup>6</sup> ) (lb-in <sup>2</sup> )	Shear (lbs)	ER <sup>(3)</sup> (lb)	IR <sup>(4)</sup> (lb)	k (x10 <sup>6</sup> ) (lb-ft/in)	Vertical Load <sup>(5)</sup> (plf)	Weight (plf)
PWI 53L	9½"	4000	207	1340	901	2065	0.478	2000	2.3
	11½"	5150	345	1565	904	2120	0.591	2000	2.5
	14"	6110	501	1765	906	2165	0.693	1100	2.8
	16"	6990	677	1955	908	2210	0.789	1100	3
PWI 36L	11½"	6445	429	1615	1025	2500	0.468	1800	3.1
	14"	7755	622	1830	1025	2500	0.55	1800	3.4
	16"	8995	836	2020	1025	2500	0.625	1800	3.6
	18"	10135	1082	2185	1175	2500	0.7	1300	3.8
PWI 56L	11½"	10170	668	2055	1145	3130	0.549	2400	4.5
	14"	12250	968	2330	1145	3130	0.641	2200	4.8
	16"	14205	1301	2585	1145	3130	0.729	1900	5
	18"	16010	1684	2845	1315	3130	0.817	1700	5.3
	20"	17800	2115	3105	1325	3130	0.905	1580	5.6
	24"	21340	3127	3620	1340	3130	1.081	1100	6

1. Values apply to normal load duration. All values except EI, k and Vertical Load may be adjusted for other load durations as permitted by the code.
2. The tabulated bending (M) values shall not be increased by any code-allowed repetitive member factor.
3. End reaction capacity (ER) of the I-joist without web stiffeners and a minimum bearing length of 1¾ inches.
4. Intermediate reaction capacity (IR) of the I-joist without web stiffeners and a minimum bearing length of 3½ inches.
5. Blocking panel and rim joist uniform vertical load capacity.

Deflection calculations shall include both bending and shear deformations. Deflection for a simple span:

Uniform Load:	Center Point Load:	Where:	
$[1] \Delta = \frac{5w\ell^4}{384EI} + \frac{w\ell^2}{12k}$	$[2] \Delta = \frac{P\ell^3}{48EI} + \frac{2P\ell}{12k}$	$\Delta$ = calculated deflection [in]	$P$ = concentrated load [lb]
		$w$ = uniform load [lb/in]	$EI$ = bending stiffness of the I-joist [lb-in <sup>2</sup> ]
		$\ell$ = design span [in]	$k$ = coefficient of shear deflection [lb-ft/in]

To review PWT I-Joist products, please visit [pwtewp.com](http://pwtewp.com).

# Floor Spans-L/480

## Solid Sawn Flange I-Joists

### ALLOWABLE RESIDENTIAL FLOOR SPANS—40 PSF LIVE LOAD AND 10 PSF DEAD LOAD—L/480

Joist Series	Depth	Simple Span (ft)				Multiple Span (ft)				Worst Case Simple or Multiple Span (ft)			
		12" o.c.	16" o.c.	19.2" o.c.	24" o.c.	12" o.c.	16" o.c.	19.2" o.c.	24" o.c.	12" o.c.	16" o.c.	19.2" o.c.	24" o.c.
PWI 18S	9½"	16'-6"	15'-2"	14'-4"	13'-4"	17'-11"	16'-5"	15'-2"	13'-6"	16'-6"	15'-2"	14'-4"	13'-4"
	11½"	19'-9"	18'-1"	17'-1"	15'-7"	21'-6"	19'-0"	17'-4"	15'-6"	19'-9"	18'-1"	17'-1"	15'-6"
PWI 20S	9½"	17'-9"	16'-2"	15'-4"	14'-3"	19'-3"	17'-7"	16'-6"	14'-9"	17'-9"	16'-2"	15'-4"	14'-3"
	11½"	21'-2"	19'-4"	18'-3"	17'-0"	23'-0"	21'-0"	19'-2"	17'-1"	21'-2"	19'-4"	18'-3"	17'-0"
	14"	24'-1"	22'-0"	20'-9"	18'-7"	26'-3"	22'-9"	20'-9"	18'-6"	24'-1"	22'-0"	20'-9"	18'-6"
	16"	26'-9"	24'-5"	22'-4"	19'-7"	28'-2"	24'-4"	22'-3"	19'-10"	26'-9"	24'-4"	22'-3"	19'-7"
PWI 32S	9½"	18'-9"	17'-0"	16'-0"	14'-9"	20'-4"	18'-5"	17'-3"	15'-11"	18'-9"	17'-0"	16'-0"	14'-9"
	11½"	22'-3"	20'-2"	19'-0"	17'-7"	24'-2"	21'-10"	20'-6"	18'-5"	22'-3"	20'-2"	19'-0"	17'-7"
	14"	25'-2"	22'-10"	21'-6"	19'-6"	27'-4"	24'-9"	23'-3"	19'-5"	25'-2"	22'-10"	21'-6"	19'-5"
	16"	27'-10"	25'-3"	23'-9"	19'-7"	30'-3"	27'-5"	25'-4"	20'-4"	27'-10"	25'-3"	23'-9"	19'-7"
PWI 42S	11½"	24'-11"	22'-8"	21'-4"	19'-10"	27'-1"	24'-8"	23'-2"	21'-7"	24'-11"	22'-8"	21'-4"	19'-10"
	14"	28'-3"	25'-9"	24'-3"	22'-6"	30'-9"	28'-0"	26'-4"	24'-6"	28'-3"	25'-9"	24'-3"	22'-6"
	16"	31'-4"	28'-6"	26'-10"	25'-0"	34'-1"	31'-0"	29'-2"	25'-9"	31'-4"	28'-6"	26'-10"	25'-0"

## LVL Flange I-Joists

### ALLOWABLE RESIDENTIAL FLOOR SPANS—40 PSF LIVE LOAD AND 10 PSF DEAD LOAD—L/480

Joist Series	Depth	Simple Span (ft)				Multiple Span (ft)				Worst Case Simple or Multiple Span (ft)			
		12" o.c.	16" o.c.	19.2" o.c.	24" o.c.	12" o.c.	16" o.c.	19.2" o.c.	24" o.c.	12" o.c.	16" o.c.	19.2" o.c.	24" o.c.
PWI 53L	9½"	18'-5"	16'-10"	15'-11"	14'-10"	20'-1"	18'-4"	17'-4"	16'-1"	18'-5"	16'-10"	15'-11"	14'-10"
	11½"	21'-10"	19'-11"	18'-10"	17'-7"	23'-9"	21'-8"	20'-6"	16'-9"	21'-10"	19'-11"	18'-10"	16'-9"
	14"	24'-8"	22'-7"	21'-4"	17'-10"	26'-11"	24'-7"	21'-5"	17'-1"	24'-8"	22'-7"	21'-4"	17'-1"
	16"	27'-3"	24'-11"	22'-5"	17'-10"	29'-8"	26'-3"	21'-10"	17'-5"	27'-3"	24'-11"	21'-10"	17'-5"
PWI 36L	11½"	23'-1"	21'-1"	19'-11"	18'-6"	25'-2"	22'-11"	21'-7"	19'-9"	23'-1"	21'-1"	19'-11"	18'-6"
	14"	26'-2"	23'-10"	22'-6"	20'-9"	28'-6"	25'-11"	24'-5"	19'-9"	26'-2"	23'-10"	22'-6"	19'-9"
	16"	28'-10"	26'-4"	24'-10"	20'-10"	31'-5"	28'-8"	24'-9"	19'-9"	28'-10"	26'-4"	24'-9"	19'-9"
PWI 56L	11½"	26'-6"	24'-1"	22'-8"	21'-1"	28'-10"	26'-2"	24'-8"	22'-11"	26'-6"	24'-1"	22'-8"	21'-1"
	14"	29'-11"	27'-3"	25'-8"	23'-4"	32'-7"	29'-8"	27'-11"	24'-9"	29'-11"	27'-3"	25'-8"	23'-4"
	16"	33'-1"	30'-1"	28'-4"	23'-5"	36'-0"	32'-9"	30'-10"	24'-9"	33'-1"	30'-1"	28'-4"	23'-5"

#### Notes:

1. Table values apply to uniformly loaded, residential floor joists.
2. Span is measured from face to face of supports. For multi-span members the shortest span shall not be less than 50% of the longest span.
3. Deflection is limited to L/240 at total load and L/480 at live load.
4. Table values are based on glued and nailed sheathing panels (23/32 APA RATED SHEATHING or 24 oc APA RATED STURD-I-FLOOR). Use an ASTM D3498 adhesive in accordance with the manufacturer's recommendations.
5. Provide at least 1¾" of bearing length at end supports and 3½" at intermediate supports.
6. Provide lateral and rotational restraint at supports (e.g. blocking panels, rim board) and lateral restraint along the compression flange of each joist (e.g. floor sheathing, gypsum board ceiling).
7. Use sizing software or consult a professional engineer to analyze conditions outside the scope of this table (e.g. commercial floors, different bearing conditions, concentrated loads) or for multiple span joists if the length of any span is less than half the length of an adjacent span.

To review PWT I-Joist products, please visit [pwtewp.com](http://pwtewp.com).

# Floor Spans-L/600

## Solid Sawn Flange I-Joists

ALLOWABLE RESIDENTIAL FLOOR SPANS—40 PSF LIVE LOAD AND 10 PSF DEAD LOAD—L/600

Joist Series	Depth	Simple Span (ft)				Multiple Span (ft)				Worst Case Simple or Multiple Span (ft)			
		12" o.c.	16" o.c.	19.2" o.c.	24" o.c.	12" o.c.	16" o.c.	19.2" o.c.	24" o.c.	12" o.c.	16" o.c.	19.2" o.c.	24" o.c.
PWI 18S	9½"	15'-3"	14'-0"	13'-2"	12'-4"	16'-7"	15'-2"	14'-4"	13'-4"	15'-3"	14'-0"	13'-2"	12'-4"
	11½"	18'-3"	16'-8"	15'-9"	14'-8"	19'-10"	18'-2"	17'-1"	15'-6"	18'-3"	16'-8"	15'-9"	14'-8"
PWI 20S	9½"	16'-4"	14'-11"	14'-1"	13'-1"	17'-9"	16'-2"	15'-3"	14'-2"	16'-4"	14'-11"	14'-1"	13'-1"
	11½"	19'-6"	17'-10"	16'-10"	15'-7"	21'-3"	19'-4"	18'-3"	16'-11"	19'-6"	17'-10"	16'-10"	15'-7"
	14"	22'-3"	20'-4"	19'-2"	17'-10"	24'-3"	22'-1"	20'-9"	18'-6"	22'-3"	20'-4"	19'-2"	17'-10"
	16"	24'-9"	22'-7"	21'-3"	19'-7"	26'-11"	24'-4"	22'-3"	19'-10"	24'-9"	22'-7"	21'-3"	19'-7"
PWI 32S	9½"	17'-3"	15'-7"	14'-8"	13'-6"	18'-8"	16'-10"	15'-9"	14'-6"	17'-3"	15'-7"	14'-8"	13'-6"
	11½"	20'-6"	18'-7"	17'-5"	16'-1"	22'-2"	20'-1"	18'-9"	17'-4"	20'-6"	18'-7"	17'-5"	16'-1"
	14"	23'-2"	21'-0"	19'-9"	18'-3"	25'-2"	22'-9"	21'-4"	19'-5"	23'-2"	21'-0"	19'-9"	18'-3"
	16"	25'-8"	23'-3"	21'-10"	19'-7"	27'-10"	25'-2"	23'-7"	20'-4"	25'-8"	23'-3"	21'-10"	19'-7"
PWI 42S	11½"	23'-0"	20'-11"	19'-8"	18'-3"	25'-0"	22'-9"	21'-4"	19'-10"	23'-0"	20'-11"	19'-8"	18'-3"
	14"	26'-1"	23'-9"	22'-4"	20'-9"	28'-5"	25'-10"	24'-3"	22'-6"	26'-1"	23'-9"	22'-4"	20'-9"
	16"	28'-11"	26'-4"	24'-9"	23'-0"	31'-6"	28'-7"	26'-11"	25'-0"	28'-11"	26'-4"	24'-9"	23'-0"

## LVL Flange I-Joists

ALLOWABLE RESIDENTIAL FLOOR SPANS—40 PSF LIVE LOAD AND 10 PSF DEAD LOAD—L/600

Joist Series	Depth	Simple Span (ft)				Multiple Span (ft)				Worst Case Simple or Multiple Span (ft)			
		12" o.c.	16" o.c.	19.2" o.c.	24" o.c.	12" o.c.	16" o.c.	19.2" o.c.	24" o.c.	12" o.c.	16" o.c.	19.2" o.c.	24" o.c.
PWI 53L	9½"	17'-0"	15'-7"	14'-8"	13'-8"	18'-6"	16'-11"	15'-11"	14'-10"	17'-0"	15'-7"	14'-8"	13'-8"
	11½"	20'-2"	18'-5"	17'-5"	16'-2"	21'-11"	20'-0"	18'-11"	16'-9"	20'-2"	18'-5"	17'-5"	16'-2"
	14"	22'-10"	20'-10"	19'-8"	17'-10"	24'-10"	22'-8"	21'-5"	17'-1"	22'-10"	20'-10"	19'-8"	17'-1"
	16"	25'-3"	23'-0"	21'-9"	17'-10"	27'-6"	25'-1"	21'-10"	17'-5"	25'-3"	23'-0"	21'-9"	17'-5"
PWI 36L	11½"	21'-4"	19'-5"	18'-4"	17'-0"	23'-2"	21'-1"	19'-11"	18'-5"	21'-4"	19'-5"	18'-4"	17'-0"
	14"	24'-2"	22'-0"	20'-9"	19'-3"	26'-3"	23'-11"	22'-6"	19'-9"	24'-2"	22'-0"	20'-9"	19'-3"
	16"	26'-8"	24'-3"	22'-11"	20'-10"	29'-0"	26'-5"	24'-9"	19'-9"	26'-8"	24'-3"	22'-11"	19'-9"
PWI 56L	11½"	24'-5"	22'-3"	20'-11"	19'-5"	26'-7"	24'-2"	22'-8"	21'-1"	24'-5"	22'-3"	20'-11"	19'-5"
	14"	27'-8"	25'-2"	23'-8"	22'-0"	30'-1"	27'-4"	25'-9"	23'-10"	27'-8"	25'-2"	23'-8"	22'-0"
	16"	30'-6"	27'-9"	26'-2"	23'-5"	33'-3"	30'-2"	28'-5"	24'-9"	30'-6"	27'-9"	26'-2"	23'-5"

### Notes:

1. Table values apply to uniformly loaded, residential floor joists.
2. Span is measured from face to face of supports. For multi-span members the shortest span shall not be less than 50% of the longest span.
3. Deflection is limited to L/240 at total load and L/600 at live load.
4. Table values are based on glued and nailed sheathing panels (23/32 APA RATED SHEATHING or 24 oc APA RATED STURD-I-FLOOR). Use an ASTM D3498 adhesive in accordance with the manufacturer's recommendations.
5. Provide at least 1¾" of bearing length at end supports and 3½" at intermediate supports.
6. Provide lateral and rotational restraint at supports (e.g. blocking panels, rim board) and lateral restraint along the compression flange of each joist (e.g. floor sheathing, gypsum board ceiling).
7. Use sizing software or consult a professional engineer to analyze conditions outside the scope of this table (e.g. commercial floors, different bearing conditions, concentrated loads) or for multiple span joists if the length of any span is less than half the length of an adjacent span.

To review PWT I-Joist products, please visit [pwtewp.com](http://pwtewp.com).



# PWT LVL Reference Design Values

2.0E 2900F <sub>b</sub> <sup>(1)(7)</sup>	
Modulus of Elasticity <sup>4</sup> , E (x 10 <sup>6</sup> )	2.0 psi <sup>(2)(6)</sup>
Bending (beam), F <sub>b</sub>	2,900 psi <sup>(3)(5)</sup>
Horizontal Shear (beam), F <sub>v</sub>	285 psi
Compression Perpendicular to Grain (beam), F <sub>c</sub>	750 psi <sup>(2)</sup>

2.1E 3100F <sub>b</sub> <sup>(1)(8)</sup>	
Modulus of Elasticity <sup>4</sup> , E (x 10 <sup>6</sup> )	2.1 psi <sup>(2)(6)</sup>
Bending (beam), F <sub>b</sub>	3,100 psi <sup>(4)(5)</sup>
Horizontal Shear (beam), F <sub>v</sub>	285 psi
Compression Perpendicular to Grain (beam), F <sub>c</sub>	850 psi <sup>(2)</sup>

1. Values apply to dry service conditions
2. Do not adjust for load duration
3. For depths > 12" adjust by (12/d)<sup>1/5</sup>, for depths < 12" adjust by (12/d)<sup>0.111</sup> where d is the depth of the member [inches]
4. Adjust by (12/d)<sup>1/5</sup>, where d is the depth of the member [inches]
5. Adjust by 1.04 for repetitive members as defined in the ANSI/AWC NDS
6. True or shear-free modulus of elasticity and does not account for shear deformation
7. See APA Product Report [PR-L233](#) and [PR-L280](#)
8. See APA Product Report [PR-L233](#)

To review PWT LVL products, please visit [pwtewp.com](http://pwtewp.com).



# 1 3/4" 2.0E 2900F<sub>b</sub> Beam and Header

## ALLOWABLE UNIFORM FLOOR LOADS\* – POUNDS PER LINEAL FOOT

Span	5 1/2"		7 1/4"		9 1/4"		9 1/2"		11 1/4"		11 1/2"		14"		16"		18"		Span
	LL	TL	LL	TL	LL	TL	LL	TL	LL	TL	LL	TL	LL	TL	LL	TL	LL	TL	
	Bearing		Bearing		Bearing		Bearing		Bearing		Bearing		Bearing		Bearing		Bearing		
6'	305	455	659	762	-	1027	-	1062	-	1324	-	1424	-	1794	-	2091	-	2090	6'
	1.5 / 3		1.8 / 4.4		2.4 / 5.9		2.5 / 6.1		3.2 / 7.6		3.4 / 8.2		4.4 / 10.3		5.1 / 12		5.1 / 12		
7'	196	260	430	573	840	848	-	876	-	1082	-	1160	-	1443	-	1741	-	1790	7'
	1.5 / 3		1.6 / 3.8		2.3 / 5.7		2.4 / 5.9		3 / 7.3		3.2 / 7.8		4.1 / 9.7		4.9 / 11.7		5.1 / 12		
8'	133	153	295	342	584	722	628	745	-	915	-	978	-	1207	-	1442	-	1565	8'
	1.5 / 3		1.5 / 3		2.3 / 5.5		2.3 / 5.7		2.9 / 7		3.1 / 7.5		3.8 / 9.2		4.6 / 11		5 / 12		
9'	94	96	211	216	421	608	454	640	723	792	837	845	-	1037	-	1231	-	1390	9'
	1.5 / 3		1.5 / 3		2.1 / 5.3		2.3 / 5.5		2.8 / 6.8		3 / 7.3		3.7 / 8.9		4.4 / 10.6		5 / 12		
10'	-	62	-	142	313	465	337	502	542	698	628	744	-	908	-	1074	-	1250	10'
	1.5 / 3		1.5 / 3		1.8 / 4.5		2 / 4.8		2.7 / 6.7		2.9 / 7.1		3.6 / 8.7		4.3 / 10.3		5 / 12		
11'	-	42	-	97	238	353	257	381	415	588	483	651	759	808	-	951	-	1104	11'
	1.5 / 3		1.5 / 3		1.5 / 3.7		1.6 / 4		2.5 / 6.2		2.8 / 6.9		3.5 / 8.5		4.1 / 10		4.8 / 11.7		
12'			-	68	186	274	200	296	325	482	379	546	599	727	-	854	-	988	12'
			1.5 / 3		1.5 / 3.2		1.5 / 3.4		2.3 / 5.6		2.6 / 6.3		3.4 / 8.4		4.1 / 9.9		4.7 / 11.4		
13'			-	48	147	216	159	234	259	383	302	447	480	627	693	775	-	894	13'
			1.5 / 3		1.5 / 3		1.5 / 3		1.9 / 4.8		2.3 / 5.6		3.2 / 7.8		4 / 9.7		4.6 / 11.2		
14'			-	35	119	173	128	188	209	309	244	361	390	539	566	687	780	816	14'
			1.5 / 3		1.5 / 3		1.5 / 3		1.7 / 4.2		2 / 4.9		3 / 7.3		3.8 / 9.3		4.5 / 11		
15'					97	141	105	153	171	252	200	295	321	469	467	597	647	739	15'
					1.5 / 3		1.5 / 3		1.5 / 3.7		1.7 / 4.3		2.8 / 6.8		3.5 / 8.6		4.4 / 10.7		
16'					80	116	87	125	142	208	166	244	267	394	390	524	542	649	16'
					1.5 / 3		1.5 / 3		1.5 / 3.3		1.5 / 3.8		2.5 / 6.1		3.3 / 8.1		4.1 / 10		
17'					67	96	72	104	119	173	139	204	225	330	329	463	458	573	17'
					1.5 / 3		1.5 / 3		1.5 / 3		1.5 / 3.4		2.2 / 5.5		3.1 / 7.6		3.8 / 9.4		
18'					57	80	61	87	101	146	118	171	190	279	279	411	390	510	18'
					1.5 / 3		1.5 / 3		1.5 / 3		1.5 / 3		2 / 4.9		2.9 / 7.2		3.6 / 8.9		
19'							52	74	86	124	101	145	163	238	239	351	335	457	19'
							1.5 / 3		1.5 / 3		1.5 / 3		1.8 / 4.4		2.6 / 6.5		3.4 / 8.4		
20'									74	105	87	124	140	204	207	302	289	412	20'
									1.5 / 3		1.5 / 3		1.6 / 4		2.4 / 5.9		3.3 / 8		
21'									64	91	75	107	122	176	179	261	252	369	21'
									1.5 / 3		1.5 / 3		1.5 / 3.7		2.2 / 5.4		3.1 / 7.6		
22'									56	78	65	92	106	153	157	227	220	322	22'
									1.5 / 3		1.5 / 3		1.5 / 3.4		2 / 4.9		2.8 / 6.9		
23'											57	80	93	133	138	199	194	282	23'
											1.5 / 3		1.5 / 3.1		1.8 / 4.5		2.6 / 6.4		
24'													82	117	122	175	171	248	24'
													1.5 / 3		1.7 / 4.2		2.4 / 5.9		
25'													73	103	108	154	152	220	25'
													1.5 / 3		1.6 / 3.9		2.2 / 5.5		
26'													65	91	96	137	136	195	26'
													1.5 / 3		1.5 / 3.6		2 / 5.1		
27'													58	80	86	121	122	174	27'
													1.5 / 3		1.5 / 3.3		1.9 / 4.7		
28'													52	71	77	108	109	155	28'
													1.5 / 3		1.5 / 3.1		1.8 / 4.4		

\* Can be applied to the beam in addition to its own weight.

LL: Live Load deflection has been limited to L/360.

TL: Total deflection has been limited to L/240. Long term deflection (creep) has not been considered. (or a maximum of 0.3125" for beams 7 1/4" deep or less) Bearing: Required end / intermediate bearing length (inches), based on bearing stress of 750 psi.

### Notes:

- Span is the center-to-center distance of the supports and is valid for simple or equal, continuous span applications.
- The values in the tables are for uniform loads only. Loads within a distance equal to the beam depth from a support must be applied to the top surface.
- Where the Live Load is a "-", the Total Load governs the design.
- Do not use a product where the load is blank (" ") without further analysis by a design professional.
- 2 plies minimum for depths greater than 16 inches.
- Total Load is for normal (100%) duration and has been adjusted to account for the self-weight of the member.
- These tables assume full lateral support of the compression edge. Full support is considered to be a maximum unbraced length of 24."
- The allowable loads in the table are for a single ply of LVL. Multiply the values by the number of plies of equal thickness to size a built-up member. Example: double the allowable loads in the table for a 2-ply member.
- The member width shall be properly built up by connecting plies of the same grade of LVL. Refer to the multiple-ply connections on page 13.

# 3½" 2.1E 3100F<sub>b</sub> Beam and Header

## ALLOWABLE UNIFORM FLOOR LOADS\* – POUNDS PER LINEAL FOOT

Span	5½"		7¼"		9¼"		9½"		11¼"		11½"		14"		16"		18"		Span
	LL	TL	LL	TL	LL	TL	LL	TL	LL	TL	LL	TL	LL	TL	LL	TL	LL	TL	
	Bearing		Bearing		Bearing		Bearing		Bearing		Bearing		Bearing		Bearing		Bearing		
6'	641	957	1385	1525	-	2056	-	2126	-	2649	-	2849	-	3591	-	4388	-	4743	6'
	1.5 / 3		1.6 / 3.9		2.1 / 5.2		2.2 / 5.4		2.8 / 6.7		3 / 7.2		3.8 / 9.1		4.7 / 11.1		5.1 / 12		
7'	412	548	904	1204	-	1698	-	1754	-	2166	-	2321	-	2889	-	3483	-	4063	7'
	1.5 / 3		1.5 / 3.6		2.1 / 5		2.1 / 5.2		2.6 / 6.4		2.8 / 6.9		3.6 / 8.5		4.3 / 10.3		5.1 / 12		
8'	280	323	620	721	1227	1446	1320	1492	-	1831	-	1958	-	2415	-	2887	-	3403	8'
	1.5 / 3		1.5 / 3		2 / 4.9		2.1 / 5		2.5 / 6.2		2.7 / 6.6		3.4 / 8.2		4.1 / 9.8		4.8 / 11.5		
9'	199	202	443	455	885	1258	953	1298	1519	1585	-	1692	-	2075	-	2464	-	2885	9'
	1.5 / 3		1.5 / 3		1.9 / 4.8		2 / 4.9		2.5 / 6		2.6 / 6.4		3.3 / 7.9		3.9 / 9.4		4.6 / 11		
10'	-	132	-	300	658	978	709	1055	1138	1398	1320	1490	-	1818	-	2149	-	2503	10'
	1.5 / 3		1.5 / 3		1.7 / 4.1		1.8 / 4.5		2.4 / 5.9		2.6 / 6.3		3.2 / 7.7		3.7 / 9.1		4.4 / 10.6		
11'	-	89	-	205	501	744	541	803	873	1249	1015	1330	1595	1618	-	1905	-	2210	11'
	1.5 / 3		1.5 / 3		1.5 / 3.5		1.5 / 3.8		2.4 / 5.8		2.5 / 6.2		3.1 / 7.5		3.6 / 8.9		4.2 / 10.3		
12'			-	143	390	577	422	624	683	1015	796	1172	1258	1457	-	1710	-	1978	12'
			1.5 / 3		1.5 / 3		1.5 / 3.2		2.1 / 5.2		2.4 / 6		3 / 7.4		3.6 / 8.7		4.1 / 10.1		
13'			-	103	310	456	335	493	544	806	635	941	1008	1325	1456	1552	-	1790	13'
			1.5 / 3		1.5 / 3		1.5 / 3		1.8 / 4.5		2.1 / 5.2		3 / 7.3		3.5 / 8.6		4 / 9.9		
14'			-	75	250	366	270	396	440	650	514	760	819	1156	1188	1420	-	1634	14'
			1.5 / 3		1.5 / 3		1.5 / 3		1.6 / 3.9		1.8 / 4.5		2.8 / 6.9		3.4 / 8.4		4 / 9.7		
15'					204	298	221	322	361	531	422	622	675	999	982	1280	1359	1503	15'
					1.5 / 3		1.5 / 3		1.5 / 3.4		1.6 / 4		2.6 / 6.4		3.3 / 8.2		3.9 / 9.6		
16'					169	245	183	265	299	439	350	514	561	830	819	1123	1138	1390	16'
					1.5 / 3		1.5 / 3		1.5 / 3		1.5 / 3.5		2.3 / 5.7		3.1 / 7.6		3.9 / 9.5		
17'					141	204	153	221	251	366	293	430	472	696	691	993	962	1229	17'
					1.5 / 3		1.5 / 3		1.5 / 3		1.5 / 3.1		2 / 5.1		2.9 / 7.2		3.6 / 8.9		
18'					119	171	129	185	212	308	248	362	401	588	587	867	819	1095	18'
					1.5 / 3		1.5 / 3		1.5 / 3		1.5 / 3		1.8 / 4.5		2.7 / 6.7		3.4 / 8.4		
19'							110	157	181	262	212	308	343	501	503	741	704	981	19'
							1.5 / 3		1.5 / 3		1.5 / 3		1.7 / 4.1		2.4 / 6		3.2 / 8		
20'									156	224	183	263	295	430	434	637	608	884	20'
									1.5 / 3		1.5 / 3		1.5 / 3.7		2.2 / 5.5		3.1 / 7.6		
21'									135	192	158	227	256	372	377	552	529	778	21'
									1.5 / 3		1.5 / 3		1.5 / 3.4		2 / 5		2.8 / 7		
22'									118	166	138	196	224	323	330	481	463	679	22'
									1.5 / 3		1.5 / 3		1.5 / 3.1		1.8 / 4.6		2.6 / 6.4		
23'											121	171	196	282	290	421	408	596	23'
											1.5 / 3		1.5 / 3		1.7 / 4.2		2.4 / 5.9		
24'													173	247	256	370	361	525	24'
													1.5 / 3		1.6 / 3.9		2.2 / 5.5		
25'													154	218	227	327	320	465	25'
													1.5 / 3		1.5 / 3.6		2 / 5.1		
26'													137	193	203	290	286	413	26'
													1.5 / 3		1.5 / 3.3		1.9 / 4.7		
27'													122	171	182	258	256	368	27'
													1.5 / 3		1.5 / 3.1		1.8 / 4.4		
28'													110	152	163	230	230	329	28'
													1.5 / 3		1.5 / 3		1.6 / 4.1		
29'														147	206	208	296	296	29'
															1.5 / 3		1.5 / 3.8		
30'															133	185	188	266	30'
															1.5 / 3		1.5 / 3.6		

\* Can be applied to the beam in addition to its own weight.

LL: Live Load deflection has been limited to L/360.

TL: Total deflection has been limited to L/240. Long term deflection (creep) has not been considered. (or a maximum of 0.3125" for beams 7¼" deep or less) Bearing: Required end / intermediate bearing length (inches), based on bearing stress of 850 psi.

### Notes:

- Span is the center-to-center distance of the supports and is valid for simple or equal, continuous span applications.
- The values in the tables are for uniform loads only. Loads within a distance equal to the beam depth from a support must be applied to the top surface.
- Where the Live Load is a "-", the Total Load governs the design.
- Do not use a product where the load is blank (" ") without further analysis by a design professional.
- 2 plies minimum for depths greater than 16 inches.
- Total Load is for normal (100%) duration and has been adjusted to account for the self-weight of the member.
- These tables assume full lateral support of the compression edge. Full support is considered to be a maximum unbraced length of 24."
- The allowable loads in the table are for a single ply of LVL. Multiply the values by the number of plies of equal thickness to size a built-up member. Example: double the allowable loads in the table for a 2-ply member.
- The member width shall be properly built up by connecting plies of the same grade of LVL. Refer to the multiple-ply connections on page 13.

# 5¼" 2.1E 3100F<sub>b</sub> Beam and Header

## ALLOWABLE UNIFORM FLOOR LOADS\* – POUNDS PER LINEAL FOOT

Span	7¼"		9¼"		9½"		11¼"		11½"		14"		16"		18"		20"		Span
	LL	TL	LL	TL	LL	TL	LL	TL	LL	TL	LL	TL	LL	TL	LL	TL	LL	TL	
	Bearing		Bearing		Bearing		Bearing		Bearing		Bearing		Bearing		Bearing		Bearing		
6'	2077	2288	-	3084	-	3190	-	3974	-	4274	-	5386	-	6582	-	7115	-	7112	6'
	1.6	3.9	2.1	5.2	2.2	5.4	2.8	6.7	3	7.2	3.8	9.1	4.7	11.1	5.1	12	5.1	12	
7'	1356	1807	-	2547	-	2631	-	3249	-	3482	-	4333	-	5225	-	6095	-	6092	7'
	1.5	3.6	2.1	5	2.1	5.2	2.6	6.4	2.8	6.9	3.6	8.5	4.3	10.3	5.1	12	5.1	12	
8'	931	1081	1841	2169	1981	2238	-	2746	-	2937	-	3623	-	4330	-	5105	-	5327	8'
	1.5	3	2	4.9	2.1	5	2.5	6.2	2.7	6.6	3.4	8.2	4.1	9.8	4.8	11.5	5.1	12	
9'	665	683	1328	1888	1430	1947	2278	2378	-	2539	-	3113	-	3697	-	4328	-	4732	9'
	1.5	3	2	4.8	2	4.9	2.5	6	2.6	6.4	3.3	7.9	3.9	9.4	4.6	11	5	12	
10'	-	450	987	1468	1064	1583	1707	2097	1981	2235	-	2728	-	3224	-	3755	-	4256	10'
	1.5	3	1.7	4.1	1.8	4.5	2.4	5.9	2.6	6.3	3.2	7.7	3.7	9.1	4.4	10.6	5	12	
11'	-	307	752	1116	812	1205	1309	1874	1523	1996	2392	2427	-	2858	-	3315	-	3803	11'
	1.5	3	1.5	3.5	1.5	3.8	2.4	5.8	2.5	6.2	3.1	7.5	3.6	8.9	4.2	10.3	4.9	11.8	
12'	-	215	586	866	633	936	1025	1522	1194	1758	1887	2185	-	2566	-	2967	-	3392	12'
	1.5	3	1.5	3	1.5	3.2	2.1	5.2	2.4	6	3	7.4	3.6	8.7	4.1	10.1	4.7	11.5	
13'	-	154	465	685	502	740	816	1209	952	1412	1512	1987	2184	2328	-	2685	-	3061	13'
	1.5	3	1.5	3	1.5	3	1.8	4.5	2.1	5.2	3	7.3	3.5	8.6	4	9.9	4.6	11.2	
14'	-	113	375	550	405	595	660	975	771	1140	1229	1734	1783	2130	-	2452	-	2789	14'
	1.5	3	1.5	3	1.5	3	1.6	3.9	1.8	4.5	2.8	6.9	3.4	8.4	4	9.7	4.5	11	
15'			306	447	331	484	541	797	633	933	1012	1499	1473	1920	2038	2255	-	2560	15'
			1.5	3	1.5	3	1.5	3.4	1.6	4	2.6	6.4	3.3	8.2	3.9	9.6	4.5	10.9	
16'			253	368	274	398	449	658	525	772	842	1245	1229	1685	1707	2085	2278	2366	16'
			1.5	3	1.5	3	1.5	3	1.5	3.5	2.3	5.7	3.1	7.6	3.9	9.5	4.4	10.7	
17'			212	306	229	331	376	549	440	645	708	1044	1036	1490	1443	1844	1931	2199	17'
			1.5	3	1.5	3	1.5	3	1.5	3.1	2	5.1	2.9	7.2	3.6	8.9	4.3	10.6	
18'			179	256	194	278	319	463	373	544	601	883	881	1300	1229	1642	1649	1988	18'
			1.5	3	1.5	3	1.5	3	1.5	3	1.8	4.5	2.7	6.7	3.4	8.4	4.1	10.2	
19'					165	235	272	393	319	462	514	752	755	1111	1056	1472	1419	1781	19'
					1.5	3	1.5	3	1.5	3	1.7	4.1	2.4	6	3.2	8	3.9	9.6	
20'							234	336	274	395	443	646	652	956	913	1326	1229	1605	20'
							1.5	3	1.5	3	1.5	3.7	2.2	5.5	3.1	7.6	3.7	9.1	
21'							203	289	237	340	385	558	566	828	794	1167	1072	1453	21'
							1.5	3	1.5	3	1.5	3.4	2	5	2.8	7	3.5	8.7	
22'							177	250	207	295	336	485	495	721	695	1019	939	1322	22'
							1.5	3	1.5	3	1.5	3.1	1.8	4.6	2.6	6.4	3.4	8.3	
23'									182	257	295	423	435	631	612	894	828	1207	23'
									1.5	3	1.5	3	1.7	4.2	2.4	5.9	3.2	8	
24'											260	371	385	555	541	788	733	1072	24'
											1.5	3	1.6	3.9	2.2	5.5	3	7.4	
25'											231	327	341	490	481	697	652	951	25'
											1.5	3	1.5	3.6	2	5.1	2.8	6.9	
26'											206	290	304	435	429	619	582	846	26'
											1.5	3	1.5	3.3	1.9	4.7	2.6	6.4	
27'											184	257	273	387	385	553	522	756	27'
											1.5	3	1.5	3.1	1.8	4.4	2.4	5.9	
28'											165	229	245	346	346	494	470	678	28'
											1.5	3	1.5	3	1.6	4.1	2.2	5.5	
29'													221	310	312	444	424	610	29'
													1.5	3	1.5	3.8	2.1	5.2	
30'													200	278	283	400	385	550	30'
													1.5	3	1.5	3.6	2	4.9	

\* Can be applied to the beam in addition to its own weight.

LL: Live Load deflection has been limited to L/360.

TL: Total deflection has been limited to L/240. Long term deflection (creep) has not been considered. (or a maximum of 0.3125" for beams 7¼" deep or less) Bearing: Required end / intermediate bearing length (inches), based on bearing stress of 850 psi.

### Notes:

- Span is the center-to-center distance of the supports and is valid for simple or equal, continuous span applications.
- The values in the tables are for uniform loads only. Loads within a distance equal to the beam depth from a support must be applied to the top surface.
- Where the Live Load is a "-", the Total Load governs the design.
- Do not use a product where the load is blank (" ") without further analysis by a design professional.
- Total Load is for normal (100%) duration and has been adjusted to account for the self-weight of the member.
- These tables assume full lateral support of the compression edge. Full support is considered to be a maximum unbraced length of 24."

To review PWT LVL products, please visit [pwtewp.com](http://pwtewp.com).

# 7" 2.1E 3100F<sub>b</sub> Beam and Header

## ALLOWABLE UNIFORM FLOOR LOADS\* – POUNDS PER LINEAL FOOT

Span	9¼"		9½"		11¼"		11½"		14"		16"		18"		20"		24"		Span
	LL	TL	LL	TL	LL	TL	LL	TL	LL	TL	LL	TL	LL	TL	LL	TL	LL	TL	
	Bearing		Bearing		Bearing		Bearing		Bearing		Bearing		Bearing		Bearing		Bearing		
6'	-	4112	-	4253	-	5299	-	5699	-	7182	-	8776	-	9487	-	9483	-	9476	6'
	2.1/5.2		2.2/5.4		2.8/6.7		3/7.2		3.8/9.1		4.7/11.1		5.1/12		5.1/12		5.1/12		
7'	-	3396	-	3508	-	4332	-	4643	-	5778	-	6967	-	8127	-	8123	-	8116	7'
	2.1/5		2.1/5.2		2.6/6.4		2.8/6.9		3.6/8.5		4.3/10.3		5.1/12		5.1/12		5.1/12		
8'	2455	2892	2641	2985	-	3662	-	3916	-	4831	-	5774	-	6807	-	7103	-	7096	8'
	2/4.9		2.1/5		2.5/6.2		2.7/6.6		3.4/8.2		4.1/9.8		4.8/11.5		5.1/12		5.1/12		
9'	1770	2517	1907	2596	3038	3171	-	3385	-	4150	-	4929	-	5770	-	6310	-	6303	9'
	2/4.8		2/4.9		2.5/6		2.6/6.4		3.3/7.9		3.9/9.4		4.6/11		5/12		5/12		
10'	1316	1957	1419	2111	2276	2796	2641	2980	-	3637	-	4299	-	5007	-	5675	-	5668	10'
	1.7/4.1		1.8/4.5		2.4/5.9		2.6/6.3		3.2/7.7		3.7/9.1		4.4/10.6		5/12		5/12		
11'	1003	1488	1082	1607	1746	2499	2030	2661	3190	3236	-	3810	-	4421	-	5070	-	5149	11'
	1.5/3.5		1.5/3.8		2.4/5.8		2.5/6.2		3.1/7.5		3.6/8.9		4.2/10.3		4.9/11.8		5/12		
12'	781	1155	844	1248	1367	2030	1592	2344	2516	2914	-	3421	-	3957	-	4523	-	4716	12'
	1.5/3		1.5/3.2		2.1/5.2		2.4/6		3/7.4		3.6/8.7		4.1/10.1		4.7/11.5		5/12		
13'	620	913	670	987	1089	1613	1270	1883	2017	2650	2912	3104	-	3580	-	4082	-	4350	13'
	1.5/3		1.5/3		1.8/4.5		2.1/5.2		3/7.3		3.5/8.6		4/9.9		4.6/11.2		5/12		
14'	500	733	540	793	881	1301	1028	1521	1639	2312	2377	2840	-	3269	-	3718	-	4036	14'
	1.5/3		1.5/3		1.6/3.9		1.8/4.5		2.8/6.9		3.4/8.4		4/9.7		4.5/11		4.9/12		
15'	408	596	442	645	722	1062	844	1244	1350	1999	1964	2560	2718	3007	-	3414	-	3764	15'
	1.5/3		1.5/3		1.5/3.4		1.6/4		2.6/6.4		3.3/8.2		3.9/9.6		4.5/10.9		4.9/12		
16'	338	491	366	531	599	878	700	1029	1123	1660	1639	2247	2276	2781	3038	3155	-	3526	16'
	1.5/3		1.5/3		1.5/3		1.5/3.5		2.3/5.7		3.1/7.7		3.9/9.5		4.4/10.7		4.9/12		
17'	283	408	306	442	502	733	587	860	945	1392	1382	1987	1924	2459	2574	2932	-	3316	17'
	1.5/3		1.5/3		1.5/3		1.5/3.1		2/5.1		2.9/7.2		3.6/8.9		4.3/10.6		4.9/12		
18'	239	342	259	371	425	617	497	725	802	1177	1175	1734	1639	2190	2199	2651	-	3129	18'
	1.5/3		1.5/3		1.5/3		1.5/3		1.8/4.5		2.7/6.7		3.4/8.4		4.1/10.2		4.9/12		
19'			220	314	363	524	425	616	686	1003	1007	1482	1408	1962	1892	2375	-	2962	19'
			1.5/3		1.5/3		1.5/3		1.7/4.1		2.4/6		3.2/8		3.9/9.6		4.9/12		
20'					312	448	366	527	591	861	869	1275	1217	1768	1639	2140	2718	2812	20'
					1.5/3		1.5/3		1.5/3.7		2.2/5.5		3.1/7.6		3.7/9.1		4.9/12		
21'					270	385	317	454	513	744	755	1104	1059	1556	1429	1938	2377	2676	21'
					1.5/3		1.5/3		1.5/3.4		2/5		2.8/7		3.5/8.7		4.9/12		
22'					236	333	276	393	448	647	660	962	927	1358	1253	1762	2090	2454	22'
					1.5/3		1.5/3		1.5/3.1		1.8/4.6		2.6/6.4		3.4/8.3		4.7/11.5		
23'							242	342	393	565	580	842	816	1192	1104	1609	1847	2241	23'
							1.5/3		1.5/3		1.7/4.2		2.4/5.9		3.2/8		4.5/11		
24'									347	495	513	740	722	1050	977	1430	1639	2055	24'
									1.5/3		1.6/3.9		2.2/5.5		3/7.4		4.3/10.6		
25'									308	437	455	654	641	930	869	1268	1461	1890	25'
									1.5/3		1.5/3.6		2/5.1		2.8/6.9		4.1/10.2		
26'									274	386	406	580	572	826	777	1129	1308	1744	26'
									1.5/3		1.5/3.3		1.9/4.7		2.6/6.4		4/9.8		
27'									245	343	364	516	513	737	696	1008	1175	1614	27'
									1.5/3		1.5/3.1		1.8/4.4		2.4/5.9		3.8/9.4		
28'									220	305	327	461	461	659	627	904	1059	1498	28'
									1.5/3		1.6/4.1		2.2/5.5		3.7/9.1		3.7/9.1		
29'											295	413	416	592	566	813	958	1393	29'
											1.5/3		1.5/3.8		2.1/5.2		3.5/8.8		
30'											267	371	377	533	513	733	869	1261	30'
											1.5/3		1.5/3.6		1.9/4.8		3.3/8.2		

\* Can be applied to the beam in addition to its own weight.

LL: Live Load deflection has been limited to L/360.

TL: Total deflection has been limited to L/240. Long term deflection (creep) has not been considered. (or a maximum of 0.3125" for beams 7¼" deep or less) Bearing: Required end / intermediate bearing length (inches), based on bearing stress of 850 psi.

### Notes:

- Span is the center-to-center distance of the supports and is valid for simple or equal, continuous span applications.
- The values in the tables are for uniform loads only. Loads within a distance equal to the beam depth from a support must be applied to the top surface.
- Where the Live Load is a "-", the Total Load governs the design.
- Do not use a product where the load is blank (" ") without further analysis by a design professional.
- Total Load is for normal (100%) duration and has been adjusted to account for the self-weight of the member.
- These tables assume full lateral support of the compression edge. Full support is considered to be a maximum unbraced length of 24."

To review PWT LVL products, please visit [pwtewp.com](http://pwtewp.com).

# Multiple-Ply PWT LVL Beam Assembly

## COMBINATIONS OF 1 3/4" AND 3 1/2" PLIES

### NAILS AND BOLTS

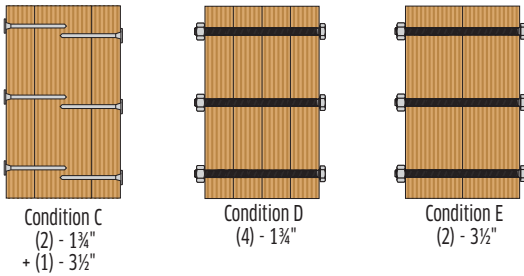
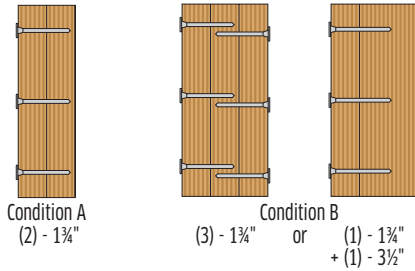

Nail Spacing

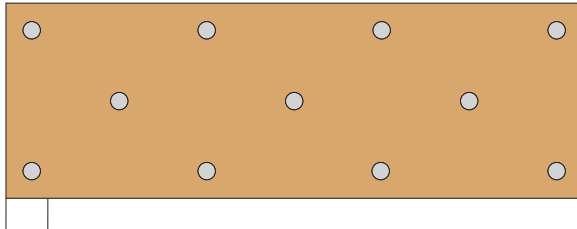

### 1 3/4" AND 3 1/2" PLIES—MAXIMUM UNIFORM SIDE LOAD (PLF)

Condition	3 3/4" x 0.131" Nails		16d Common Nails	
	2 Rows at 12" o.c.	3 Rows at 12" o.c.	2 Rows at 12" o.c.	3 Rows at 12" o.c.
Condition A (2-1 3/4")	390	585	565	845
Condition B (3-1 3/4" OR 1-1 3/4" + 1-3 1/2")	290	435	425	635
Condition C (2-1 3/4" + 1-3 1/2")	260	390	375	565
Condition D (4-1 3/4")	Use bolts for this condition			
Condition E (2-3 1/2")	Use bolts for this condition			

#### Notes:

- For 1 1/2" thick PWT LVL, the Maximum Uniform Side Loads must be multiplied by 0.86.
- The table values for nails may be doubled for 6" o.c. and tripled for 4" o.c. nail spacings.
- The nail schedules shown apply to both sides of a three-ply beam.
- The table values apply to bolts meeting the requirements of ANSI/ASME Standard B18.2.1. A standard cut washer, or metal plate or strap of equal or greater dimensions, shall be provided between the wood and the bolt head and between the wood and the nut. The distance from the edge of the beam to the bolt holes must be at least 2" for 1/2" bolts. Bolt holes shall be the same diameter as the bolt.
- 7" wide beams must be loaded from both sides and/or top loaded.
- Beams wider than 7" must be designed by the engineer of record.
- Load duration factors may be applied to the table values.
- For proprietary fastener alternatives, consult the manufacturer's literature.

#### Minimum fastener schedule for top-loaded beams:

Conditions A, B & C, beams 12" deep or less: 2 rows 3 3/4" x 0.131" at 12" o.c.  
 Conditions A, B & C, beams deeper than 12": 3 rows 3 3/4" x 0.131" at 12" o.c.  
 Conditions D & E, all beam depths: 2 rows 1/2" bolts at 24" o.c.

To review PWT's Installation Guide, please visit [pwtewp.com](http://pwtewp.com).

## COMBINATIONS OF 1 3/4" PLIES

### STRONG-DRIVE® SDW STRUCTURAL WOOD SCREWS

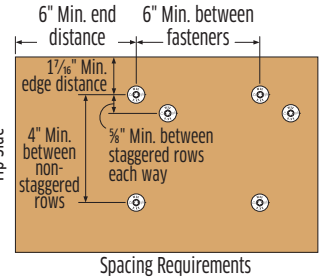
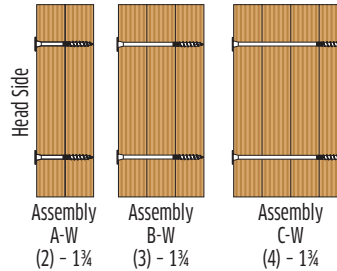

### SIDELOADED 1 3/4" MULTI-PLY SCL ASSEMBLIES – ALLOWABLE UNIFORM LOAD APPLIED TO EITHER OUTSIDE MEMBER

Multiple Members	Nominal Screw Length (in)	Loaded Side	Structural Composite Lumber						
			SDW @ 12" o.c.		SDW @ 16" o.c.		SDW @ 24" o.c.		
Assembly	Components		2 Rows	3 Rows	2 Rows	3 Rows	2 Rows	3 Rows	
A-W	2-ply SCL	3 3/8"	Either	1600	2400	1200	1800	800	1200
				B-W	3-ply SCL	5	Head	1200	1800
C-W	4-ply SCL	6 3/8"	Tip	900	1350	675	1015	450	675
				Head	1065	1600	800	1200	535
			Tip	800	1200	600	900	400	600

- Each ply is assumed to carry same proportion of load.
- Loads may be applied to the head side and point side concurrently provided neither published allowable load is exceeded. (Example: a 3-ply assembly with a head side load of 1300 plf and point side load of 1000 plf may be fastened together with 3 rows of SDW @ 16" o.c.)
- When hangers are installed on point side, hanger face fasteners must be a minimum of 3" long.
- Tables are based on Main Member Penetration as noted in Single-Fastener Load Tables of the *Simpson Strong-Tie Fastening Systems 2017-2018 Catalog C-F-2017* (page 358).
- Please consult [strongtie.com](http://strongtie.com) for the latest fastener details and data.

#### Installation

- SDW screws install best with a low-speed 1/2" drill and a T-40 6-lobe bit. The matched bit included with the screws is recommended for best results.
- Screw heads that are countersunk flush to the wood surface are acceptable if the screw has not spun out.
- Individual screw locations may be adjusted up to 3" to avoid conflicts with other hardware or to avoid lumber defects.

#### SCREW DIMENSIONS

Model No.	Nominal Screw Length (L) (in)	Thread Length (TL) (in)	Head Stamp Length
SDW22338	3 3/8"	1 1/16"	3.37
SDW22500	5	1 1/16"	5.00
SDW22634	6 3/8"	1 1/16"	6.75

- Pre-drilling is typically not required.

## How to Use the Maximum Uniform Side Load Table

### EXAMPLE: THREE 1 3/4" PLIES LOADED FROM BOTH SIDES AND ABOVE (COND. B)

- Use allowable load tables or sizing software to size the beam to carry a total load of (300 + 610 + 550) = 1460 plf.

- Refer to the Condition B row in the table. Scan across the row from left to right for a table value greater than 550 plf, which is the greatest side load carried by the beam. The fourth value in the row indicates that 3 rows of 16d common nails at 12" o.c. will accommodate a side load of 635 plf which is greater than the 550 plf required. Use 3 rows of 16d common nails at 12" o.c., from both sides, to assemble the beam.

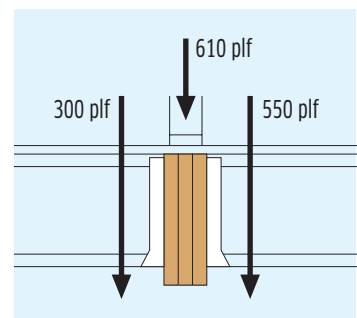

# PWT TREATED™

TREATED RIGHT™



## PWT Treated LVL

### Treated Laminated Veneer Lumber

#### Product Highlights

- PWT Treated LVL is the only manufacturer-treated LVL, and it is covered by a 25-year limited, transferable warranty.
- PWT Treated LVL is protected against damage caused by fungal rot, decay, and wood-destroying insects, including Formosan termites (interior or exterior usage).
- We use a proprietary and CODE APPROVED treatment system and process, utilizing TRU-CORE® technology.

#### The Product

- PWT Treated LVL may be used in exterior construction above-ground applications (UC3B) and for components that are difficult to maintain, repair, or replace and that are critical to the performance and safety of the entire system:
  - Deck substructures, sill plates, and fascia
- Treatment is added during the LVL manufacturing process, which fully penetrates throughout each veneer layer, offering complete protection from the inside out.
- No treatment gradient – and double (2X) the preservative retention required in various standards around the world
- Additionally, envelope treated for best surface properties

#### Features and Benefits

- **Non-corrosive!**
  - PWT Treated LVL and its chemical additive do not corrode or damage hardware.
  - Choose appropriate coating on connectors for the project conditions.
- Interior use
- Stainable and paintable
- No added VOCs
- Code Reports [ESR-2909](#), [ESR-3834](#), [PR-L329](#), and [FL 39762](#)

#### GRADE

2.0E 2800 F<sub>b</sub>

#### BEAM SIZES

Width	Depth				
1 1/4" x	9 1/2"	11 1/2"	14"	16"	18"
3 1/2" x	9 1/2"	11 1/2"	14"	16"	-
*5 1/4" x	9 1/2"	11 1/2"	14"	16"	-

\*5 1/4" members are industrial grade only; the product must be kept wrapped prior to installation, be flashed on-site, and should be clad when an architectural- or appearance-grade finish is required.

#### JOISTS (DIMENSION SIZES)

Width	Depth				
1 1/2" x	3 1/2"	5 1/2"	7 1/4"	9 1/4"	11 1/4"

## PWT Treated LVL Sill Plate

- All the features and benefits of PWT Treated LVL
- Long, straight, and true for quick installation and minimal waste
- Non-corrosive—does not require special galvanized hardware

#### REFERENCE DESIGN VALUES (DRY USE – 100% LOAD DURATION)

	Beam Orientation	Plank Orientation
Modulus of Elasticity, E <sup>(1)(4)</sup> =	2,000,000 psi	2,000,000 psi
Adjusted Modulus of Elasticity, E <sub>min</sub> <sup>(1)(5)</sup> =	985,000 psi	985,000 psi
Bending Stress, F <sub>b</sub> <sup>(2)(3)</sup> =	2,800 psi	2,800 psi
Compression Perpendicular to Grain, F <sub>c⊥</sub> <sup>(1)</sup> =	850 psi	650 psi
Compression Parallel to Grain, F <sub>c  </sub> =	2,500 psi	2,500 psi
Horizontal Shear, F <sub>v</sub> =	285 psi	150 psi

- (1) Do not adjust for load duration.
- (2) Adjust by (12/d)<sup>0.2</sup>, where d is the depth of the member [inches].
- (3) Adjust by 1.04 for repetitive members as defined in the NDS.
- (4) True (Shear-Free) modulus of elasticity does not account for shear deformation.
- (5) Reference modulus of elasticity for beam & column stability calculations in accordance with the NDS.

#### Notes:

1. PWT Treated used as sill plate requires gasket seal.
2. See APA Product Reports [PR-L329](#) and [ESR-2909](#) for additional design criteria.

# Joist Lengths

## Improved Performance



DRY USE – 40 PSF LIVE LOAD AND 10 PSF DEAD LOAD – L/480

Product	Nominal Size [in]	Actual Size [in]	With or Without 2' Cantilever		
			Joist Spacing (o.c.)		
			12"	16"	24"
PWT Treated LVL	2 x 6	1½ x 5½	10' 6"	9' 6"	8' 3"
	2 x 8	1½ x 7¼	13' 9"	12' 6"	10' 11"
	2 x 10	1½ x 9¼	17' 7"	15' 11"	13' 10"
	2 x 12	1½ x 11¼	21' 4"	19' 4"	16' 10"
Pressure Treated No. 2 Southern pine	2 x 8	1½ x 7¼	12' 4"	11' 1"	9' 1"
	2 x 10	1½ x 9¼	15' 2"	13' 2"	10' 9"
	2 x 12	1½ x 11¼	17' 10"	15' 6"	12' 8"
Pressure Treated No. 2 Hem-fir (incised)	2 x 8	1½ x 7¼	11' 10"	10' 5"	8' 6"
	2 x 10	1½ x 9¼	14' 8"	12' 9"	10' 5"
	2 x 12	1½ x 11¼	17' 0"	14' 9"	12' 1"

**Notes:**

- Spans are the overall length of a simple span. Up to a 2' cantilever can be added to the overall length at one end.
- End bearing length must be at least 1.5".
- Cantilever bearing length must be at least 3".
- Joists require support across their full thickness or width.
- Joist tables are based upon 100% duration of load.
- Use the Exacte by PWT software for conditions outside the scope of this guide.
- Lateral bracing for the compression edge must be provided.
- Provide support to prevent lateral movement and rotation at the bearings.
- The spans for Pressure Treated Dimension Lumber are provided as a reference only. Do not use these spans for specification or design.

DRY USE – 60 PSF LIVE LOAD AND 10 PSF DEAD LOAD – L/480

Product	Nominal Size [in]	Actual Size [in]	With or Without 2' Cantilever		
			Joist Spacing (o.c.)		
			12"	16"	24"
PWT Treated LVL	2 x 6	1½ x 5½	9' 2"	8' 3"	7' 3"
	2 x 8	1½ x 7¼	12' 0"	10' 11"	9' 6"
	2 x 10	1½ x 9¼	15' 4"	13' 10"	12' 1"
	2 x 12	1½ x 11¼	18' 7"	16' 10"	14' 8"
Pressure Treated No. 2 Southern pine	2 x 8	1½ x 7¼	10' 10"	9' 5"	7' 8"
	2 x 10	1½ x 9¼	12' 10"	11' 2"	9' 1"
	2 x 12	1½ x 11¼	15' 1"	13' 1"	10' 9"
Pressure Treated No. 2 Hem-fir (incised)	2 x 8	1½ x 7¼	10' 2"	8' 10"	7' 3"
	2 x 10	1½ x 9¼	12' 5"	10' 9"	8' 10"
	2 x 12	1½ x 11¼	14' 5"	12' 6"	10' 2"

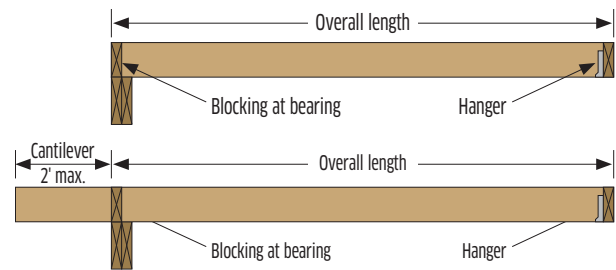

# Beam Spans

## Improved Performance

DRY USE – 40 PSF LIVE LOAD AND 10 PSF DEAD LOAD – L/480

Size [in]	Deck Joist Overall Length with 2' Cantilever [ft]						
	6	8	10	12	14	16	18
	Deck Joist Overall Length [ft]						
	10	12	14	16	18	20	22
3½ x 9½	13'-8"	13'-0"	12'-5"	11'-11"	11'-5"	11'-1"	10'-9"
3½ x 11½	17'-1"	16'-2"	15'-5"	14'-10"	14'-3"	13'-9"	13'-4"
3½ x 14	20'-1"	19'-1"	18'-2"	17'-5"	16'-9"	16'-2"	15'-8"
3½ x 16	22'-11"	21'-9"	20'-9"	19'-10"	19'-1"	18'-5"	17'-10"
2-ply 1½ x 18	25'-9"	24'-5"	23'-3"	22'-4"	21'-6"	20'-9"	20'-1"
5¼ x 9½	15'-9"	14'-11"	14'-3"	13'-8"	13'-2"	12'-8"	12'-4"
5¼ x 11½	19'-7"	18'-7"	17'-9"	17'-0"	16'-4"	15'-10"	15'-4"
5¼ x 14	23'-0"	21'-10"	20'-10"	20'-0"	19'-3"	18'-7"	18'-0"
5¼ x 16	26'-3"	24'-11"	23'-10"	22'-10"	22'-0"	21'-3"	20'-7"
3-ply 1½ x 18	29'-7"	28'-1"	26'-9"	25'-8"	24'-8"	23'-10"	23'-1"

**Notes:**

- Beams spans are defined as overall length, simple spans only.
- Bearing length must be at least 3.5".
- Beams require support across their full thickness or width.
- Beam spans are based upon 100% duration of load.
- Use the Exact by PWT software for conditions outside the scope of this guide.
- Lateral bracing for the compression edge must be provided.
- Provide support to prevent lateral movement and rotation at the bearings.

DRY USE – 60 PSF LIVE LOAD AND 10 PSF DEAD LOAD – L/480

Size [in]	Deck Joist Overall Length with 2' Cantilever [ft]						
	6	8	10	12	14	16	18
	Deck Joist Overall Length [ft]						
	10	12	14	16	18	20	22
3½ x 9½	11'-11"	11'-4"	10'-10"	10'-4"	9'-11"	9'-7"	9'-4"
3½ x 11½	14'-10"	14'-1"	13'-5"	12'-10"	12'-5"	11'-11"	11'-7"
3½ x 14	17'-6"	16'-7"	15'-10"	15'-2"	14'-7"	14'-1"	13'-7"
3½ x 16	19'-11"	18'-11"	18'-0"	17'-3"	16'-7"	16'-0"	15'-6"
2-ply 1½ x 18	22'-5"	21'-3"	20'-3"	19'-5"	18'-8"	18'-0"	17'-5"
5¼ x 9½	13'-8"	13'-0"	12'-5"	11'-11"	11'-5"	11'-1"	10'-9"
5¼ x 11½	17'-1"	16'-2"	15'-5"	14'-10"	14'-3"	13'-9"	13'-4"
5¼ x 14	20'-1"	19'-1"	18'-2"	17'-5"	16'-9"	16'-2"	15'-8"
5¼ x 16	22'-11"	21'-9"	20'-9"	19'-10"	19'-1"	18'-5"	17'-10"
3-ply 1½ x 18	25'-9"	24'-5"	23'-3"	22'-4"	21'-6"	20'-9"	20'-1"

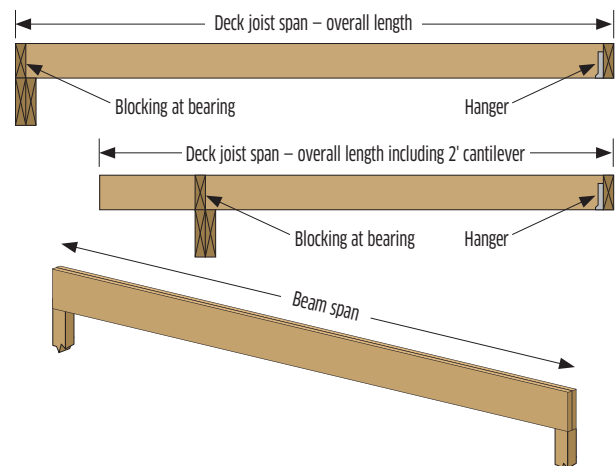



**PWT**<sup>™</sup>

**FOCUSED ON EWP**

1850 Park Lane Burlington, WA 98233

TF 888.707.2285

[pwtewp.com](http://pwtewp.com)

For product catalog and complete warranty details or for more information on the full line of PWT products or the nearest distributor, visit [pwtewp.com](http://pwtewp.com).

PWT products are manufactured at different locations in the United States and Canada.

**⚠ CAL. PROP 65 WARNING:** Drilling, sawing, sanding or machining wood products can expose you to wood dust, a substance known to the State of California to cause cancer. Avoid inhaling wood dust or use a dust mask or other safeguards for personal protection. For more information go to [www.P65Warnings.ca.gov/wood](http://www.P65Warnings.ca.gov/wood).

© 2024 Pacific Woodtech Corporation. All rights reserved. APA, APA Rated, and APA Product Report are registered trademarks of APA – The Engineered Wood Association. SIMPSON Strong-Tie® is a registered trademark of Simpson Strong-Tie Company, Inc. MiTek® is a registered trademark of MiTek Holdings, Inc. PWT™ is a registered trademark of Pacific Woodtech Corporation. Printed in USA. Specifications (details) subject to change without notice.

NOTE: PWT periodically updates and revises its product information. To verify that this version is current, contact the nearest sales office, visit [pwtewp.com](http://pwtewp.com), or call 888.707.2285.

**PWT**<sup>™</sup>

**FOCUSED ON EWP**