

PWI Joists (formerly SolidStart[®]) Fire-Rated Assemblies PR-S238
Pacific Woodtech Corporation Revised April 6, 2023

Products: PWI Joists (formerly SolidStart[®]) and SolidStart[®] LVL Rim Boards
Pacific Woodtech Corporation, 1850 Park Lane, Burlington, Washington 98233
(360) 707-2200
www.pacificwoodtech.com

1. Basis of the product report:
 - 2021, 2018, 2015, and 2012 International Building Code (IBC): Sections 104.11 Alternative materials, 703 Fire-Resistance Ratings and Fire Tests, 721 Prescriptive Fire Resistance, 722.6 Wood assemblies, and 2303.1.2 Prefabricated wood I-joists
 - 2021, 2018, and 2015 International Residential Code (IRC): Sections R104.11 Alternative materials, and R502.1.2 and R802.1.8 (2021 and 2018 IRC only) Prefabricated wood I-joists
 - 2012 IRC: Sections R104.11 Alternative materials, R502.1.4 Prefabricated wood I-joists, and R501.3 Fire protection of floors
 - 2020 National Building Code of Canada (NBC): Clause 1.2.1.1 of Division A, Clauses 3.1.7, 4.1, 4.3.1.1, 9.10.3.1, 9.11, and 9.23.4.2 of Division B, Table 9.10.3.1.B, and Appendix D
 - ASTM D5055-16, D5055-13e1, D5005-13, and D5055-09 recognized in the 2021 IBC and IRC, 2018 IBC and IRC, 2015 IBC and IRC, and 2012 IBC and IRC, respectively
 - ASTM D7672-14e1, ASTM D7672-14 and ASTM D7672-12 recognized in the 2021 IBC and IRC, 2018 IBC and IRC, and 2015 IBC and IRC, respectively
 - American Wood Council Design for Code Acceptance DCA 3, Fire-Rated Wood-Frame Wall and Floor/Ceiling Assemblies
 - APA System Report SR-405
 - ICC-ES/APA ESR-1305 and ESR-2403
 - CCMC 11518-R, 12412-R, 13308-L, and 13319-R
 - APA Product Reports PR-L238, PR-L238(C), PR-L280, and PR-L280(C)
 - ASTM E119 and CAN/ULC S101 full-scale fire test reports, and engineering analyses
2. Product description:

PWI Joists covered in this report, as described in Table 1, are made with laminated veneer lumber (LVL) or lumber flanges and oriented strand board (OSB) webs in accordance with the in-plant manufacturing standard approved by APA. SolidStart LVL rim boards covered in this report are made with LVL in accordance with ASTM D7672 and the in-plant manufacturing standard approved by APA.
3. Design properties:

Design properties for PWI Joists are provided in ICC-ES/APA ESR-1305 and APA PR-L238 in the U.S., and CCMC 12412-R and APA PR-L238(C) in Canada. Design properties for SolidStart LVL rim boards are provided in ICC-ES/APA ESR-2403 and APA PR-L280 in the U.S., and CCMC 11518-R and 13319-R, and APA PR-L280(C) in Canada.
4. Product installation:

PWI Joists and SolidStart LVL rim boards covered in this report shall be installed in accordance with the recommendations provided by the manufacturer (<https://pacificwoodtech.com>). The Rim Board protection provided by the gypsum board as shown in Assemblies RB1 through RB6 in this report shall be continuous when the Rim Board is parallel to the floor joists. When the floor joists are perpendicular to the Rim Board, the gypsum board protection is permitted to be continuous or discontinuous. When the Rim Board protection is discontinuous due to interruption from the floor joists, the floor joists must abut the continuous Rim Board, and the required gypsum protection must abut the

floor joists with gaps of no greater than 1/16 inch. When the floor joists are I-joists, the gypsum protection must be notched to abut the I-joist flanges and web with gaps no greater than 1/16 inch, or the space between the I-joist web and the gypsum protection must be filled with a web filler attached to the web with a gap of no greater than 1/16 inch between the web filler and the I-joist flanges and between the gypsum protection and the web filler.

5. Fire-rated assemblies:
PWI Joists and SolidStart LVL rim boards covered in this report have been shown through testing and engineering analysis to achieve the fire resistance ratings described in this report. Fire-rated assemblies for PWI Joists and SolidStart LVL rim boards shall be constructed in accordance with the prescriptive requirements provided in this report or recommended by the manufacturer (see link above). In addition, LPI Series I-joists shall be permitted for use in the fire-rated assemblies described in Sections of ICC-ES/APA ESR-1305, when installed in accordance with the requirements specified therein.
6. Fire-protection of floors:
PWI Joists with a minimum depth of 9-1/2 inch, as shown in Table 2, when installed and protected as specified in APA System Report SR-405 (www.apawood.org/resource-library), and FP-11 shown in this report, meet the requirements of the 2021, 2018, and 2015 IRC Section R302.13 and the 2012 IRC Section R501.3 or are alternatives to the 2-by-10 dimension lumber prescribed in Exception 4 to the 2021, 2018, and 2015 IRC Section R302.13 and the 2012 IRC Section R501.3 with demonstrated equivalent fire performance.
7. Limitations:
 - a) PWI Joists covered in this report shall be designed in accordance with the code using the design properties specified in ICC-ES/APA ESR-1305 and APA PR-L238 in the U.S., and CCMC 12412-R and APA PR-L238(C) in Canada. SolidStart LVL rim boards covered in this report shall be designed in accordance with the code using the design properties specified in ICC-ES/APA ESR-2403 and APA PR-L280 in the U.S., and CCMC 11518-R and APA PR-L280(C) in Canada.
 - b) PWI Joists and SolidStart LVL rim boards covered in this report are limited to dry service conditions where the average equilibrium moisture content of sawn lumber is less than 16% in the U.S. and the average equilibrium moisture content of solid-sawn lumber over a year is 15% or less and does not exceed 19% in Canada.
 - c) PWI Joists and SolidStart LVL rim boards covered in this report are permitted for use in fire-rated assemblies that meet the fire-resistance rating in accordance with the calculation method specified in NBC Appendix D-2.3.
 - d) PWI Joists covered in this report are produced at Pacific Woodtech Corporation facility in Red Bluff, California, Resolute Engineered Wood Larouche Inc.'s facility in Larouche, Quebec, and Resolute Engineered Wood St. Prime Limited Partnership's facility in St.-Prime, Quebec, under a quality assurance program audited by APA.
 - e) SolidStart LVL rim boards covered in this report are produced at Pacific Woodtech Corporation facility in Golden, British Columbia, Canada, under a quality assurance program audited by APA.
 - f) This report is subject to re-examination in one year.
8. Identification:
PWI Joists I-joists and SolidStart LVL rim boards covered in this report are identified by a label bearing the manufacturer's name (Pacific Woodtech Corporation) and/or trademark, the APA assigned plant number (1066 for the Golden plant, 1069 for the Red Bluff plant, 1068 for the Larouche plant of Resolute Engineered Wood Larouche Inc., and 1077 for the St. Prime plant of Resolute Engineered Wood St. Prime Limited Partnership), the product series or grade, the APA logo, and a means of identifying the date of manufacture.

Table 1. Description of PWI Joists ^(a)

Joist Series	Joist Depths (in.)	Flanges				Web	
		Material	G ^(b)	Dimension		Material	Thickness ^(d) (in.)
				Depth (in.)	Width (in.)		
LPI 18/ PWI 18S	7-7/8 - 16	Proprietary SPF	0.42	1-1/2	2-1/2	OSB	3/8
LPI 20Plus/ PWI 20S	7-7/8 - 16	Proprietary SPF	0.42	1-1/2	2-1/2	OSB	3/8
LPI 32Plus/ PWI 32S	7-7/8 - 16	MSR SPF	0.46	1-1/2	2-1/2	OSB	3/8
LPI 42Plus/ PWI 42S	7-7/8 - 24	Proprietary SPF	0.46 ^(c)	1-1/2	3-1/2	OSB	3/8 ^(e)
LPI 52Plus/ PWI 52S	9-1/4 - 24	MSR SPF	0.50	1-1/2	3-1/2	OSB	7/16
LPI 36/ PWI 36L	11-7/8 - 24	LVL	0.50	1-1/2	2-1/4	OSB	3/8
LPI 530/ PWI 53L	9-1/2 - 16	LVL	0.50	1-5/16	2-1/16	OSB	3/8
LPI 56/ PWI 56L	11-7/8 - 24	LVL	0.50	1-1/2	3-1/2	OSB	7/16

^(a) Referenced dimensions are nominal. Tolerances are as specified in the in-plant quality manual.

^(b) Specific gravity of flanges for use in diaphragm design (see Table 4) based on oven-dry weight and oven-dry volume for lumber flanges or equivalent specific gravity for LVL flanges.

^(c) Specific gravity of flanges for LPI 42Plus/PWI 42S series I-joists stamped with mill number 1069 (Red Bluff, CA) is 0.50.

^(d) 7/16-inch webs shall be permitted to substitute for 3/8-inch webs.

^(e) 7/16-inch webs for joist depths exceeding 16 inches.

Table 2. Applicable PWI Joists for SR-405 Assemblies

Assembly in SR-405	Applicable Joist Series
FP-01	LPI 18/PWI 18S, LPI 20Plus/PWI 20S, LPI 32Plus/PWI 32S, LPI 36/PWI 36L, LPI 42Plus/PWI 42S, LPI 52Plus/PWI 52S, LPI 56/PWI 56L, and LPI 530/PWI 53L
FP-02 ^(a)	LPI 18/PWI 18S, LPI 20Plus/PWI 20S, LPI 32Plus/PWI 32S, LPI 36/PWI 36L, LPI 42Plus/PWI 42S, LPI 52Plus/PWI 52S, and LPI 56/PWI 56L
FP-03 ^(a)	LPI 18/PWI 18S, LPI 20Plus/PWI 20S, LPI 32Plus/PWI 32S, LPI 36/PWI 36L, LPI 42Plus/PWI 42S, LPI 52Plus/PWI 52S, LPI 56/PWI 56L, and LPI 530/PWI 53L
FP-04 ^(a)	LPI 18/PWI 18S, LPI 20Plus/PWI 20S, LPI 32Plus/PWI 32S, LPI 36/PWI 36L, LPI 42Plus/PWI 42S, LPI 52Plus/PWI 52S, LPI 56/PWI 56L, and LPI 530/PWI 53L
FP-06 ^(a)	LPI 18/PWI 18S, LPI 20Plus/PWI 20S, LPI 32Plus/PWI 32S, LPI 36/PWI 36L, LPI 42Plus/PWI 42S, LPI 52Plus/PWI 52S, LPI 56/PWI 56L, and LPI 530/PWI 53L
FP-07 ^(a)	LPI 18/PWI 18S, LPI 20Plus/PWI 20S, LPI 32Plus/PWI 32S, LPI 36/PWI 36L, LPI 42Plus/PWI 42S, LPI 52Plus/PWI 52S, LPI 56/PWI 56L, and LPI 530/PWI 53L
FP-09 ^(a)	LPI 18/PWI 18S, LPI 20Plus/PWI 20S, LPI 32Plus/PWI 32S, LPI 36/PWI 36L, LPI 42Plus/PWI 42S, LPI 52Plus/PWI 52S, LPI 56/PWI 56L, and LPI 530/PWI 53L
FP-11 ^(a,b)	LPI 18/PWI 18S, LPI 20Plus/PWI 20S, LPI 32Plus/PWI 32S, LPI 42Plus/PWI 42S, LPI 52Plus/PWI 52S, and LPI 56/PWI 56L

^(a) Minimum joist depth of 9-1/2 inches.

^(b) Assembly shown in this report, but outside of SR-405.



Pacific Woodtech Corporation Assembly PWI1.1

One-Hour Fire Resistance Rated Floor/Ceiling Assembly*

This fire resistance design is listed in accordance with the International Building Code (IBC) and American Wood Council's Design for Code Acceptance (DCA) 3

Min. 9-1/4 inches (235 mm) Deep: LPI 42Plus/PWI 42S, LPI 52Plus/PWI 52S, and LPI 56/PWI 56L I-Joists

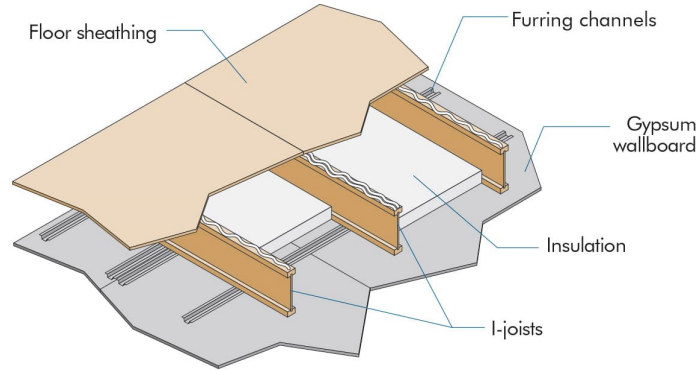

A. BASIC ASSEMBLIES

- 1) Floor Topping (Optional): Varies (reference sound ratings if applicable).
- 2) Floor Sheathing: Min. 23/32-inch (18-mm) T&G Wood Structural Panel. A construction adhesive must be applied to the top of the joists prior to placing sheathing. The sheets shall be installed with their long edge perpendicular to the joists with end joints centered over the top flange of joists. Floor sheathing must be installed per code requirements.
- 3) Insulation: Min. 1-1/2-inch (38-mm) Mineral Wool Insulation Batts (min. 2.5 pcf). Installed adjacent to the bottom flange of the I-joist and supported by the furring channels. Ends of batts shall be centered over furring channels.
- 4) Structural Members: Min. 9-1/4 inches (235 mm) Deep I-Joists. Max. 24 inch (610 mm) on center spacing. Min. flange thickness of 1-1/2 inches (38 mm) and each flange area of at least 5.25 inches² (3,387 mm²). Min. web thickness of 3/8 inch (9.5 mm).
- 5) Furring Channels: Min. 0.026-inch (0.66-mm) Hat Shaped Galvanized Steel Channels attached perpendicular to the bottom flange of the I-joist with 1-5/8-inch (41-mm) Type S drywall screws. Channels are spaced a max. of 16 inches (406 mm) on center, are doubled at each wallboard end joint, and extend to the next joist beyond each joint.
- 6) Ceiling: One layer of 5/8-inch (16-mm) Type C Gypsum Wallboard. Installed with long dimension perpendicular to furring channels and fastened with min. 1-1/8-inch (29-mm) Type S drywall screws spaced at 12 inches (305 mm) on center on intermediate joists and 8 inches (203 mm) on center at end joints, and 3/4 inch (19 mm) from wallboard edges and ends. The end joints of the wallboard must be staggered.
 - a) Finish: The face layer joints must be covered with tape and coated with joint compound. Screw heads must also be covered with joint compound.

B. SOUND RATING^(a,b)

Joist/RC Spacing ^(c)	Without Gypsum Concrete				With 1-in. (25-mm) Gypsum Concrete			
	Cushioned Vinyl		Carpet & Pad		Cushioned Vinyl		Carpet & Pad	
	STC	IIC	STC	IIC	STC	IIC	STC	IIC
24"/16" o.c.	48 (51)	42 (43)	48 (51)	61 (63)	63 (65)	50 (52)	63 (65)	65 (67)
16"/16" o.c.	44 (46)	37 (39)	44 (46)	60 (61)	56 (57)	46 (47)	56 (57)	58 (59)

- ^(a) Sound ratings from the American Wood Council publication Design for Code Acceptance (DCA) 3, available from www.awc.org/.
- ^(b) STC and IIC values established by engineering analysis based on 1.5-in. (38-mm) thick mineral wool batt insulation. Values in parentheses are based on 3.5-in. (89-mm) thick mineral wool batt insulation.
- ^(c) STC and IIC values for 16 in. (406 mm) o.c. joist spacing are applicable to 19.2-in. (488 mm) o.c. joist spacing.

C. SIMILAR ASSEMBLIES

- 1) 2012/2015/2018/2021 IBC Table 721.1(3) Item 24-1.1, and DCA 3 WIJ-1.1.
- 2) Assemblies that meet the fire-resistance rating in accordance with NBC Table 9.10.3.1.-B or the calculation method specified in NBC Appendix D-2.3.

* This assembly may also be used in a fire-rated roof/ceiling assembly, but only when constructed exactly as described.

REPRESENTING THE ENGINEERED WOOD INDUSTRY



Pacific Woodtech Corporation Assembly PWI1.2

One-Hour Fire Resistance Rated Floor/Ceiling Assembly*

This fire resistance design is listed in accordance with the International Building Code (IBC) and

American Wood Council's Design for Code Acceptance (DCA) 3

Min. 9-1/4 inches (235 mm) Deep: LPI 42Plus/PWI 42S (depths > 16 inches), LPI 52Plus/PWI 52S, and LPI 56/PWI 56L I-Joists

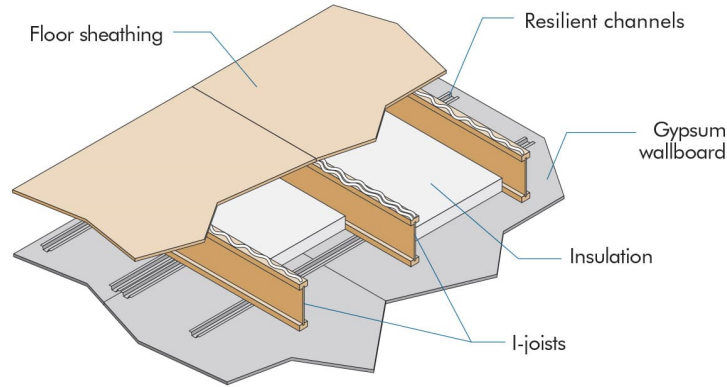

A. BASIC ASSEMBLIES

- 1) Floor Topping (Optional): Varies (reference sound ratings if applicable).
- 2) Floor Sheathing: Min. 23/32-inch (18-mm) T&G Wood Structural Panel. A construction adhesive must be applied to the top of the joists prior to placing sheathing. The sheets shall be installed with their long edge perpendicular to the joists with end joints centered over the top flange of joists. Floor sheathing must be installed per code requirements.
- 3) Insulation: Min. 1-1/2-inch (38-mm) Mineral Wool Insulation Batts (min. 2.5 pcf). Installed adjacent to the bottom flange of the I-joist and supported by the resilient channels. The ends of the batts shall be centered over resilient channels.
- 4) Structural Members: Min. 9-1/4 inches (235 mm) Deep I-Joists. Max. 24 inches (610 mm) on center spacing. Min. flange thickness of 1-1/2 inches (38 mm) and each flange area of at least 5.25 inches² (3,387 mm²). Min. web thickness of 7/16 inch (11 mm).
- 5) Resilient Channels: Min. 0.019-inch (0.5-mm) Galvanized Resilient Channels. Attached perpendicular to the bottom flange of the I-joist with 1-5/8-inch (41-mm) Type S drywall screws. Channels are spaced a max. of 16 inches (406 mm) on center, are doubled at each wallboard end joint, and extend to the next joist beyond each joint.
- 6) Ceiling: One layer of 5/8-inch (16-mm) Type C Gypsum Wallboard. Installed with long dimension perpendicular to resilient channels and fastened with min. 1-inch (25-mm) Type S drywall screws spaced at 12 inches (305 mm) on center on intermediate joists and 8 inches (203 mm) on center at end joints, and 3/4 inch (19 mm) from wallboard edges and ends. The end joints of the wallboard must be staggered.
 - a) Finish: The face layer joints must be covered with tape and coated with joint compound. Screw heads must also be covered with joint compound.

B. SOUND RATING^(a,b)

Joist/RC Spacing ^(c)	Without Gypsum Concrete				With 1-in. (25-mm) Gypsum Concrete			
	Cushioned Vinyl		Carpet & Pad		Cushioned Vinyl		Carpet & Pad	
	STC	IIC	STC	IIC	STC	IIC	STC	IIC
24"/16" o.c.	48 (51)	42 (43)	48 (51)	61 (63)	63 (65)	50 (52)	63 (65)	65 (67)
16"/16" o.c.	44 (46)	37 (39)	44 (46)	60 (61)	56 (57)	46 (47)	56 (57)	58 (59)

^(a) Sound ratings from the American Wood Council publication Design for Code Acceptance (DCA) 3, available from www.awc.org/.

^(b) STC and IIC values established by engineering analysis based on 1.5-in. (38-mm) thick mineral wool batt insulation. Values in parentheses are based on 3.5-in. (89-mm) thick mineral wool batt insulation.

^(c) STC and IIC values for 16 in. (406 mm) o.c. joist spacing are applicable to 19.2-in. (488 mm) o.c. joist spacing.

C. SIMILAR ASSEMBLIES

- 1) 2012/2015/2018/2021 IBC Table 721.1(3) Item 25-1.1, and DCA 3 WIJ-1.2.
- 2) Assemblies that meet the fire-resistance rating in accordance with NBC Table 9.10.3.1.-B or the calculation method specified in NBC Appendix D-2.3.

* This assembly may also be used in a fire-rated roof/ceiling assembly, but only when constructed exactly as described.

REPRESENTING THE ENGINEERED WOOD INDUSTRY



Pacific Woodtech Corporation Assembly PWI1.3

One-Hour Fire Resistance Rated Floor/Ceiling Assembly*

This fire resistance design is listed in accordance with the International Building Code (IBC) and American Wood Council's Design for Code Acceptance (DCA) 3

Min. 9-1/4 inches (235 mm) Deep: LPI 18/PWI 18S, LPI 20Plus/PWI 20S, LPI 32Plus/PWI 32S, LPI 36/PWI 36L, LPI 42Plus/PWI 42S, LPI 52Plus/PWI 52S, LPI 56/PWI 56L, and LPI 530/PWI 53L I-Joists

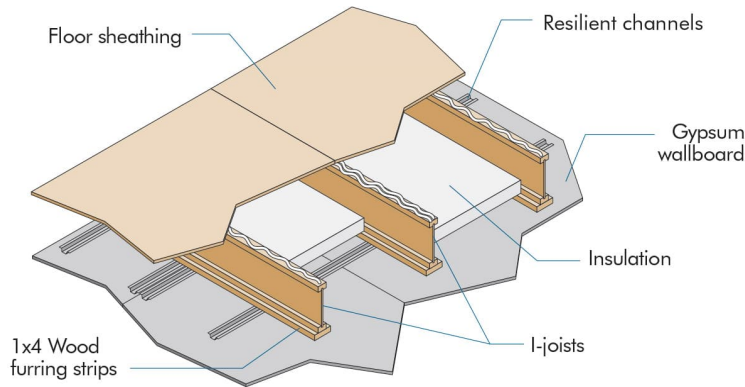

A. BASIC ASSEMBLIES

- 1) Floor Topping (Optional): Varies (reference sound ratings if applicable).
- 2) Floor Sheathing: Min. 23/32-inch (18-mm) T&G Wood Structural Panel. The sheets shall be installed with their long edge perpendicular to the joists with end joints centered over the top flange of joists. Floor sheathing must be installed per code requirements.
- 3) Insulation: Min. 2-inch (51-mm) Mineral Wool Insulation Batts (min. 3.5 pcf). Installed adjacent to the bottom flange of the I-joist and supported by 1x4 wood furring strip spacer. The ends of the batts shall be centered over resilient channels.
- 4) Structural Members: Min. 9-1/4 inches (235 mm) Deep I-Joists. Max. 24 inches (610 mm) on center spacing. Min. flange thickness of 1-5/16 inches (33 mm) and each flange area of at least 2.25 inches² (1,452 mm²). Min. web thickness of 3/8 inch (9.5 mm).
- 5) Wood Furring Strip Spacers: Min. nominal 1 inch (25 mm) x 4 inches (102 mm) attached with 1-1/2-inch (38-mm) long drywall screws at 24 inches (610 mm) on center along the bottom of the bottom flange of each I-joist.
- 6) Resilient Channels: Min. 0.019-inch (0.5-mm) Galvanized Resilient Channels (1/2-inch or 13-mm deep single leg). Attached perpendicular to the wood furring strip and bottom flange of the I-joist with 1-7/8 inch (48-mm) Type S drywall screws. Channels are spaced a max. of 16 inches (406 mm) on center, are doubled at each wallboard end joint, and extend to the next joist beyond each joint.
- 7) Ceiling: One layer of 5/8-inch (16-mm) Type C Gypsum Wallboard. Installed with long dimension perpendicular to resilient channels and fastened with min. 1-1/8-inch (29-mm) Type S drywall screws spaced at 7 inches (178 mm) on center, and 3/4 inch (19 mm) from wallboard edges and ends. The end joints of the wallboard must be staggered.
 - a) Finish: The face layer joints must be covered with tape and coated with joint compound. Screw heads must also be covered with joint compound.

B. SOUND RATING^(a,b)

Joist/RC Spacing ^(c)	Without Gypsum Concrete				With 1-in. (25-mm) Gypsum Concrete			
	Cushioned Vinyl		Carpet & Pad		Cushioned Vinyl		Carpet & Pad	
	STC	IIC	STC	IIC	STC	IIC	STC	IIC
24"/16" o.c.	50 (51)	43 (43)	52	66	63 (65)	51 (52)	63 (65)	67 (67)
16"/16" o.c.	45 (46)	38 (39)	45 (46)	60 (61)	57 (57)	46 (47)	57 (57)	59 (59)

^(a) Sound ratings from the American Wood Council publication Design for Code Acceptance (DCA) 3, available from www.awc.org/.

^(b) STC and IIC values established by engineering analysis based on 1.5-in. (38-mm) thick mineral wool batt insulation. Values in parentheses are based on 3.5-in. (89-mm) thick mineral wool batt insulation.

^(c) STC and IIC values for 16 in. (406 mm) o.c. joist spacing are applicable to 19.2-in. (488 mm) o.c. joist spacing.

C. SIMILAR ASSEMBLIES

- 1) 2012/2015/2018/2021 IBC Table 721.1(3) Item 23-1.1, and DCA 3 WIJ-1.3.
- 2) Assemblies that meet the fire-resistance rating in accordance with NBC Table 9.10.3.1.-B or the calculation method specified in NBC Appendix D-2.3.

* This assembly may also be used in a fire-rated roof/ceiling assembly, but only when constructed exactly as described.

REPRESENTING THE ENGINEERED WOOD INDUSTRY



Pacific Woodtech Corporation Assembly PWI1.4
 One-Hour Fire Resistance Rated Floor/Ceiling Assembly*

This fire resistance design is listed in accordance with *American Wood Council's Design for Code Acceptance (DCA) 3*
 Min. 9-1/4 inches (235 mm) Deep: LPI 18/PWI 18S, LPI 20Plus/PWI 20S, LPI 32Plus/PWI 32S, LPI 42Plus/PWI 42S, LPI 52Plus/PWI 52S, and LPI 56/PWI 56L I-Joists

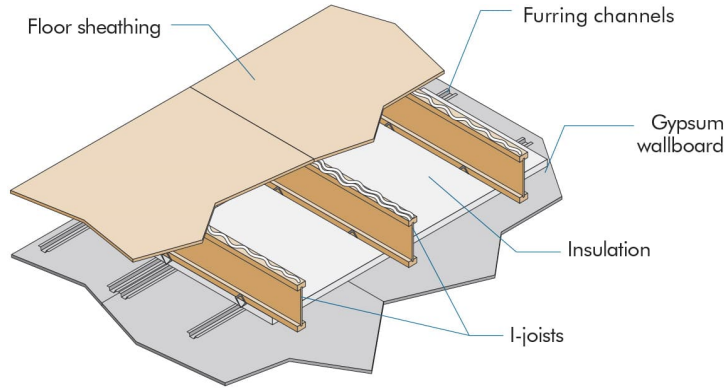

A. BASIC ASSEMBLIES

- 1) Floor Topping (Optional): Varies (reference sound ratings if applicable).
- 2) Floor Sheathing: Min. 23/32-inch (18-mm) T&G Wood Structural Panel. The sheets shall be installed with their long edge perpendicular to the joists with end joints centered over the top flange of joists. Floor sheathing must be installed per code requirements.
- 3) Insulation: Min. 1-inch (25-mm) Mineral Wool Insulation Batts (min. 6 pcf) with width equal to on-center spacing of the I-joists. Installed below the bottom flange of the I-joist and on top of furring channels with sides butted against support clips. The ends of the batts shall be centered over furring channels with batts tightly butted at all joints.
- 4) Structural Members: Min. 9-1/4 inches (235 mm) Deep I-Joists. Max. 24 inches (610 mm) on center spacing. Min. flange thickness of 1-1/2 inches (38 mm) and each flange area of at least 3.45 inches² (2,226 mm²). Min. web thickness of 3/8 inch (9.5 mm).
- 5) Furring Channels: Min. 0.019-inch (0.5-mm) Hat Shaped Galvanized Steel Channels attached perpendicular to the bottom flange of the I-joist with Simpson Type CSC support clips at each intersection with the I-joists. Clips nailed to the side of bottom flange with one 1-1/2-inch (38-mm) long No. 11 gage nail. Channels are spaced a max. of 24 inches (610 mm) on center, are doubled at each wallboard end joint, and extend to the next joist beyond each joint. At channel splices, adjacent pieces overlapped a minimum of 6 inches (152 mm) and tied with a double strand of No. 18 gage galvanized steel wire at each end of the overlap. A row of furring channel located on each side of wallboard end joints and spaced 2-1/4 inches (57 mm) from the end joint (4-1/2 inches or 114 mm on center).
- 6) Ceiling: One layer of 1/2-inch (13-mm) Type C Gypsum Wallboard. Installed with long dimension perpendicular to furring channels and fastened with min. 1-inch (25-mm) Type S drywall screws spaced at 12 inches (305 mm) on center on intermediate joists, 6 inches (152 mm) on center at end joints, and 3/4 inch (19 mm) from wallboard edges and ends. The end joints of the wallboard must be staggered and the furring channels must extend a min. of 6 inches (152 mm) beyond each end of the joint.
 - a) Finish: The face layer joints must be covered with tape and coated with joint compound. Screw heads must also be covered with joint compound.

B. SOUND RATING^(a,b)

Joist/RC Spacing	Without Gypsum Concrete				With 3/4-in. (19-mm) Gypsum Concrete			
	Cushioned Vinyl		Carpet & Pad		Cushioned Vinyl		Carpet & Pad	
	STC	IIC	STC	IIC	STC	IIC	STC	IIC
24"/24" o.c.	--	--	46	68	51	47	50	73

^(a) Sound ratings from the American Wood Council publication Design for Code Acceptance (DCA) 3, available from www.awc.org/.

^(b) STC and IIC values are based on tests of assemblies with 5/8-in. (15.9-mm) thick gypsum boards.

C. SIMILAR ASSEMBLIES

- 1) DCA 3 WIJ-1.4.
- 2) Assemblies that meet the fire-resistance rating in accordance with NBC Table 9.10.3.1.-B or the calculation method specified in NBC Appendix D-2.3.

* This assembly may also be used in a fire-rated roof/ceiling assembly, but only when constructed exactly as described.

REPRESENTING THE ENGINEERED WOOD INDUSTRY



Pacific Woodtech Corporation Assembly PWI1.5
 One-Hour Fire Resistance Rated Floor/Ceiling Assembly*

This fire resistance design is listed in accordance with *American Wood Council's Design for Code Acceptance (DCA) 3*
 Min. 9-1/4 inches (235 mm) Deep: LPI 18/PWI 18S, LPI 20Plus/PWI 20S, LPI 32Plus/PWI 32S, LPI 36/PWI 36L, LPI 42Plus/PWI 42S, LPI 52Plus/PWI 52S, and LPI 56/PWI 56L I-Joists

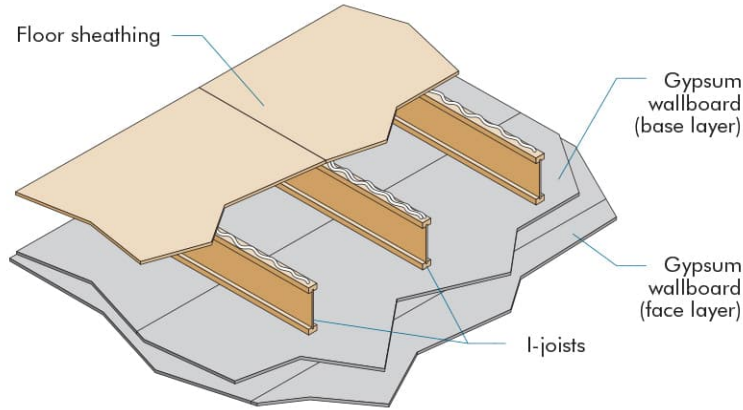

A. BASIC ASSEMBLIES

- 1) Floor Topping (Optional): Varies (reference sound ratings if applicable).
- 2) Floor Sheathing: Min. 23/32-inch (18-mm) T&G Wood Structural Panel. The sheets shall be installed with their long edge perpendicular to the joists with end joints centered over the top flange of joists. Floor sheathing must be installed per code requirements.
- 3) Structural Members: Min. 9-1/4 inches (235 mm) Deep I-Joists. Max. 24 inches (610 mm) on center spacing. Min. flange thickness of 1-1/2 inches (38 mm) and each flange area of at least 2.25 inches² (1,452 mm²). Min. web thickness of 3/8 inch (9.5 mm).
- 4) Ceiling: Two layers of 1/2-inch (13-mm) Type C Gypsum Wallboard.
 - a) Base Layer: Install with long dimension perpendicular to joist length. Attach to the bottom flange of the joists using 1-inch (25-mm) Type S drywall screws at 12 inches (305 mm) on center. The end joints of the wallboard must be centered on the bottom flange of the joist and must be staggered.
 - b) Face Layer: Install with long dimension perpendicular to joist length. Attach to the bottom flange of the joists through the base layer using 1-5/8-inch (41-mm) Type S drywall screws spaced at 12 inches (305 mm) on center on intermediate joists and 8 inches (203 mm) on center at end joints. The longitudinal joints of this layer must be offset 24 inches (610 mm) from those of the base layer. The end joints must be centered on the bottom flange of the joists and offset a min. of 48 inches (1219 mm) from those of the base layer. Additionally, face layer end joints are attached to the base layer with 1-1/2-inch (38-mm) Type G drywall screws at 8 inches (203 mm) on center with a 4-inch (102-mm) stagger, placed 6 inches (152 mm) either side of the joint.
 - c) Finish: The face layer joints must be covered with tape and coated with joint compound. Screw heads must also be covered with joint compound.

B. SOUND RATING^(a,b)

Joist Spacing	Without Gypsum Concrete				With 3/4-in. (19-mm) Gypsum Concrete			
	Cushioned Vinyl		Carpet & Pad		Cushioned Vinyl		Carpet & Pad	
	STC	IIC	STC	IIC	STC	IIC	STC	IIC
24" o.c.	--	--	--	--	--	--	49	55

^(a) Sound ratings from the American Wood Council publication Design for Code Acceptance (DCA) 3, available from www.awc.org/.

^(b) STC and IIC values are based on engineering analysis performed by David L. Adams Associates, Inc.

C. SIMILAR ASSEMBLIES

- 1) DCA 3 WIJ-1.5.
- 2) Assemblies that meet the fire-resistance rating in accordance with NBC Table 9.10.3.1.-B or the calculation method specified in NBC Appendix D-2.3.

* This assembly may also be used in a fire-rated roof/ceiling assembly, but only when constructed exactly as described.

REPRESENTING THE ENGINEERED WOOD INDUSTRY



Pacific Woodtech Corporation Assembly PW11.6
 One-Hour Fire Resistance Rated Floor/Ceiling Assembly* †

This fire resistance design is listed in accordance with *American Wood Council's Design for Code Acceptance (DCA) 3*
Min. 9-1/2 inches (241 mm) Deep: LPI 18/PWI 18S, LPI 20Plus/PWI 20S, LPI 32Plus/PWI 32S, LPI 36/PWI 36L, LPI 42Plus/PWI 42S, LPI 52Plus/PWI 52S, LPI 56/PWI 56L, and LPI 530/PWI 53L I-Joists

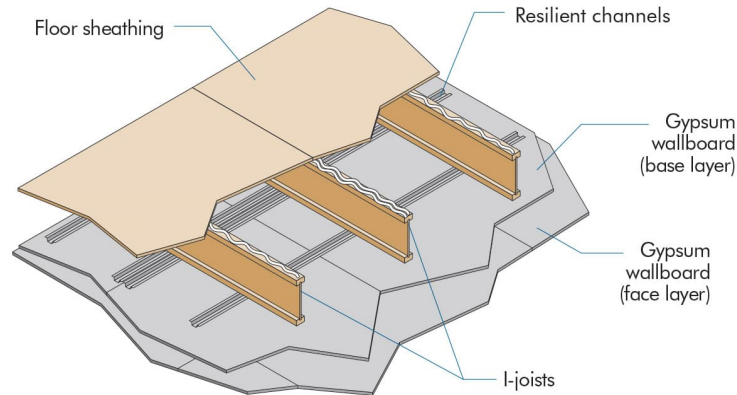

A. BASIC ASSEMBLIES

- 1) Floor Topping (Optional): Varies (reference sound ratings if applicable).
- 2) Floor Sheathing: Min. 23/32-inch (18-mm) T&G Wood Structural Panel. The sheets shall be installed with their long edge perpendicular to the joists with end joints centered over the top flange of joists. Floor sheathing must be installed per code requirements.
- 3) Structural Members: Min. 9-1/2 inches (241 mm) Deep I-Joists. Max. 24 inch (610 mm) on center spacing. Min. flange thickness of 1-5/16 inches (33 mm) and each flange area of at least 1.95 inches² (1,258 mm²). Min. web thickness of 3/8 inch (9.5 mm).
- 4) Resilient Channels[†]: Min. 0.019-inch (0.5-mm) Galvanized Resilient Channels. Attached perpendicular to the bottom flange of the I-joist with 1-1/4-inch (32-mm) Type S drywall screws. Channels are spaced a max. of 16 inches (406 mm) on center (24 inches or 610 mm when I-joists are spaced a max. of 16 inches or 406 mm on center), are doubled at each base layer wallboard end joint, and extend to the next joist beyond each joint.
- 5) Ceiling: Two layers of 1/2-inch (13-mm) Type X Gypsum Wallboard.
 - a) Base Layer: Install with long dimension perpendicular to resilient channels. Attach to the resilient channels using 1-1/4 inch (32-mm) Type S drywall screws at 12 inches (305 mm) on center. The end joints of the wallboard must be staggered.
 - b) Face Layer: Install with long dimension perpendicular to resilient channels. Attach to the resilient channels through the base layer using 1-5/8-inch (41-mm) Type S drywall screws spaced at 12 inches (305 mm) on center. The longitudinal joints of this layer must be offset 24 inches (610 mm) from those of the base layer. Additionally, face layer end joints are attached to the base layer with 1-1/2-inch (38-mm) Type G drywall screws at 8 inches (203 mm) on center placed 1-1/2 inches (38 mm) either side of the joint.
 - c) Finish: The face layer joints must be covered with tape and coated with joint compound. Screw heads must also be covered with joint compound.

B. SOUND RATING^(a,b)

Joist/RC Spacing ^(c)	Without Gypsum Concrete				With 1-in. (25-mm) Gypsum Concrete			
	Cushioned Vinyl		Carpet & Pad		Cushioned Vinyl		Carpet & Pad	
	STC	IIC	STC	IIC	STC	IIC	STC	IIC
24"/16" o.c.	46	44	46	61	58	47 (51)	58	67
16"/24" o.c.	47	43	47	64	60	49 (52)	60	67

^(a) Sound ratings from the American Wood Council publication Design for Code Acceptance (DCA) 3, available from www.awc.org/.

^(b) STC and IIC values established by engineering analysis. Values in parentheses are based on laminate wood flooring over a 0.08-in. (2-mm) closed-cell foam underlay, in lieu of cushioned vinyl flooring.

^(c) STC and IIC values for 16 in. (406 mm) o.c. joist spacing are applicable to 19.2-in. (488 mm) o.c. joist spacing.

C. SIMILAR ASSEMBLIES

- 1) 2012/2015/2018/2021 IBC Table 721.1(3) Item 27-1.1, and DCA 3 WIJ-1.6.
- 2) Assemblies that meet the fire-resistance rating in accordance with NBC Table 9.10.3.1.-B or the calculation method specified in NBC Appendix D-2.3.

* This assembly may also be used in a fire-rated roof/ceiling assembly, but only when constructed exactly as described.

† Direct attachment of gypsum wallboard in lieu of attachment to resilient channels is typically deemed acceptable. When gypsum wallboard is directly attached to the I-joists, the wallboard shall be installed with the long dimension perpendicular to the I-joists and sound rating for LPI1.5 Assembly shall be used.

REPRESENTING THE ENGINEERED WOOD INDUSTRY



Pacific Woodtech Corporation Assembly PW11.7
 One-Hour Fire Resistance Rated Floor/Ceiling Assembly*

This fire resistance design is listed in accordance with *American Wood Council's Design for Code Acceptance (DCA) 3*
Min. 9-1/2 inches (241 mm) Deep: LPI 18/PWI 18S, LPI 20Plus/PWI 20S, LPI 32Plus/PWI 32S, LPI 36/PWI 36L, LPI 42Plus/PWI 42S, LPI 52Plus/PWI 52S, and LPI 56/PWI 56L I-Joists

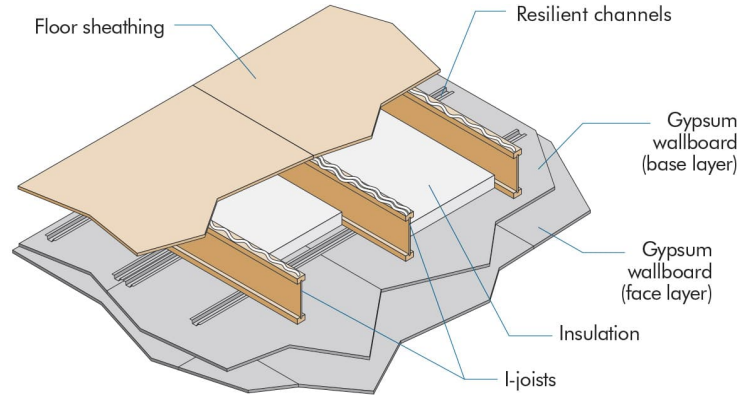

A. BASIC ASSEMBLIES

- 1) Floor Topping (Optional): Varies (reference sound ratings if applicable).
- 2) Floor Sheathing: Min. 23/32-inch (18-mm) T&G Wood Structural Panel. The sheets shall be installed with their long edge perpendicular to the joists with end joints centered over the top flange of joists. Floor sheathing must be installed per code requirements.
- 3) Insulation: Glass Fiber Insulation. Installed between I-joists and supported by resilient channels.
- 4) Structural Members: Min. 9-1/2 inches (241 mm) Deep I-Joists. Max. 24 inches (610 mm) on center spacing. Min. flange thickness of 1-1/2 inches (38 mm) and each flange area of at least 2.25 inches² (1,452 mm²). Min. web thickness of 3/8 inch (9.5 mm).
- 5) Resilient Channels: Min. 0.019-inch (0.5-mm) Galvanized Resilient Channels. Attached perpendicular to the bottom flange of the I-joist with 1-1/4 inch (32-mm) Type S drywall screws. Channels are spaced a max. of 16 inches (406 mm) on center (24 inches or 610 mm when I-joists are spaced a max. of 16 inches or 406 mm on center), are doubled at each base layer wallboard end joint, and extend to the next joist beyond each joint..
- 6) Ceiling: Two layers of 1/2-inch (13-mm) Type X Gypsum Wallboard.
 - a) Base Layer: Install with long dimension perpendicular to resilient channels. Attach to the resilient channels using 1-1/4 inch (32-mm) Type S drywall screws at 12 inches (305 mm) on center. The end joints of the wallboard must be staggered.
 - b) Face Layer: Install with long dimension perpendicular to resilient channels. Attach to the resilient channels through the base layer using 1-5/8-inch (41-mm) Type S drywall screws spaced at 12 inches (305 mm) on center. The longitudinal joints of this layer must be offset 24 inches (610 mm) from those of the base layer. Additionally, face layer end joints are attached to the base layer with 1-1/2-inch (38-mm) Type G drywall screws at 8 inches (203 mm) on center placed 1-1/2 inches (38 mm) either side of the joint.
 - c) Finish: The face layer joints must be covered with tape and coated with joint compound. Screw heads must also be covered with joint compound.

B. SOUND RATING^(a,b)

Joist/RC Spacing ^(c)	Without Gypsum Concrete				With 1-in. (25-mm) Gypsum Concrete			
	Cushioned Vinyl		Carpet & Pad		Cushioned Vinyl		Carpet & Pad	
	STC	IIC	STC	IIC	STC	IIC	STC	IIC
24"/16" o.c.	56	51	56	69	64	53	64	71
16"/24" o.c.	55	48 (51)	55	67	64	54	64	67

^(a) Sound ratings from the American Wood Council publication *Design for Code Acceptance (DCA) 3*, available from www.awc.org/.

^(b) STC and IIC values established by engineering analysis based on 3.5-in. (89-mm) thick glass fiber insulation. Values in parentheses are based on laminate wood flooring over a 0.08-in. (2-mm) closed-cell foam underlay, in lieu of cushioned vinyl flooring.

^(c) STC and IIC values for 16 in. (406 mm) o.c. joist spacing are applicable to 19.2-in. (488 mm) o.c. joist spacing.

C. SIMILAR ASSEMBLIES

- 1) 2015/2018/2021 IBC Table 721.1(3) Item 30-1.1 and DCA 3 WIJ-1.7.
- 2) Assemblies that meet the fire-resistance rating in accordance with NBC Table 9.10.3.1.-B or the calculation method specified in NBC Appendix D-2.3.

* This assembly may also be used in a fire-rated roof/ceiling assembly, but only when constructed exactly as described.

REPRESENTING THE ENGINEERED WOOD INDUSTRY



Pacific Woodtech Corporation Assembly PWI1.8

One-Hour Fire Resistance Rated Floor/Ceiling Assembly*

This fire resistance design is listed in accordance with the International Building Code (IBC)

Min. 9-1/4 inches (235 mm) Deep: LPI 18/PWI 18S, LPI 20Plus/PWI 20S, LPI 32Plus/PWI 32S, LPI 36/PWI 36L, LPI 42Plus/PWI 42S, LPI 52Plus/PWI 52S, and LPI 56/PWI 56L I-Joists

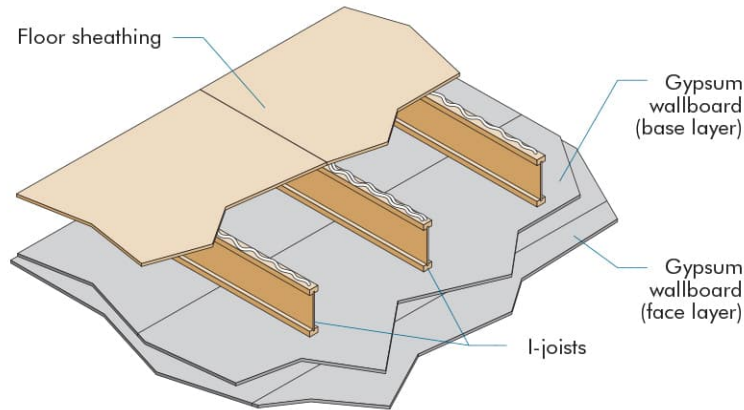

A. BASIC ASSEMBLIES

- 1) Floor Topping (Optional): Varies (reference sound ratings if applicable).
- 2) Floor Sheathing: Min. 23/32-inch (18-mm) T&G Wood Structural Panel. The sheets shall be installed with their long edge perpendicular to the joists with end joints centered over the top flange of joists. Floor sheathing must be installed per code requirements.
- 3) Structural Members: Min. 9-1/4 inches (235 mm) Deep I-Joists. Max. 24 inches (610 mm) on center spacing. Min. flange thickness of 1-1/2 inches (38 mm) and each flange area of at least 2.25 inches² (1,452 mm²). Min. web thickness of 3/8 inch (9.5 mm).
- 4) Ceiling:
 - a) Base Layer: Install with long dimension perpendicular to joist length. Attach to the bottom flange of the joists using 1-5/8-inch (41-mm) Type S drywall screws at 12 inches (305 mm) on center. The end joints of the wallboard must be centered on the bottom flange of the joist and must be staggered the equivalent of two joist spacings with those of adjacent sheets.
 - b) Face Layer: Install with long dimension perpendicular to joist length. Attach to the bottom flange of the joists through the base layer using 2-inch (51-mm) Type S drywall screws spaced at 12 inches (305 mm) on center on intermediate joists and 8 inches (203 mm) on center at end joints. Face layer end joint must not occur on the same joist as base layer end joints. The longitudinal joints of this layer must be offset 24 inches (610 mm) from those of the base layer. Additionally, face layer end joints are attached to the base layer with 1-1/2-inch (38-mm) Type G drywall screws at 8 inches (203 mm) on center placed 6 inches (152 mm) either side of the joint.
 - c) Finish: The face layer joints must be covered with tape and coated with joint compound. Screw heads must also be covered with joint compound.

B. SOUND RATING

Information not available.

C. SIMILAR ASSEMBLIES

- 1) 2012/2015/2018/2021 IBC Table 721.1(3) Item 26-1.1.
- 2) Assemblies that meet the fire-resistance rating in accordance with NBC Table 9.10.3.1.-B or the calculation method specified in NBC Appendix D-2.3.

* This assembly may also be used in a fire-rated roof/ceiling assembly, but only when constructed exactly as described.

REPRESENTING THE ENGINEERED WOOD INDUSTRY



Pacific Woodtech Corporation Assembly PWI1.9

One-Hour Fire Resistance Rated Floor/Ceiling Assembly* †

This fire resistance design is listed in accordance with the ASTM E119 and CAN/ULC S101

Min. 9-1/2 inches (241 mm) Deep: LPI 18/PWI 18S, LPI 20Plus/PWI 20S, LPI 32Plus/PWI 32S, LPI 42Plus/PWI 42S, LPI 52Plus/PWI 52S, and LPI 56/PWI 56L I-Joists

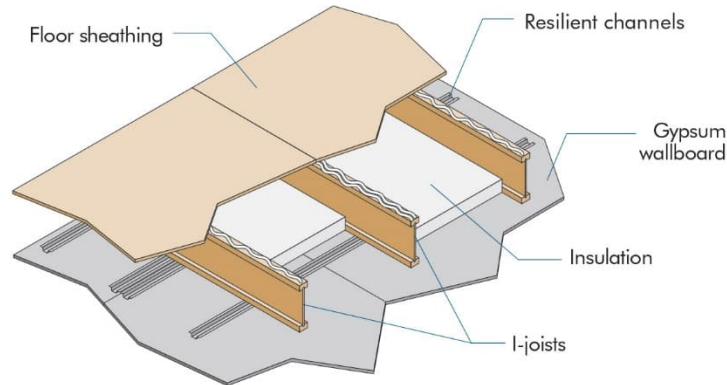

A. BASIC ASSEMBLIES

- 1) Floor Topping (Optional): Varies (reference sound ratings if applicable).
- 2) Floor Sheathing: Min. 23/32-inch (18-mm) T&G Wood Structural Panel. A construction adhesive must be applied to the top of the joists prior to placing sheathing. The sheets shall be installed with their long edge perpendicular to the joists with end joints centered over the top flange of joists. Floor sheathing must be installed per code requirements.
- 3) Insulation: Min. 3-1/2-inch (89-mm) Fiber Glass Insulation (R13). Installed adjacent to the bottom flange of the I-joist and supported by the resilient channels.
- 4) Structural Members: Min. 9-1/2-inch (241-mm) Deep I-Joists. Max. 24 inches (610 mm) on center spacing. Min. flange thickness of 1-1/2 inches (38 mm) and each flange area of at least 3.75 inches² (2,419 mm²). Min. web thickness of 3/8 inch (9.5 mm).
- 5) Resilient Channels: Min. 0.019-inch (0.5-mm) Galvanized Resilient Channels. Attached perpendicular to the bottom flange of the I-joist with 1-1/4-inch (32-mm) Type W drywall screws. Channels are spaced a max. of 16 inches (406 mm) on center, are doubled at each wallboard end joint, and extend to the next joist beyond each joint.
- 6) Ceiling: One layer of 3/4-inch (19-mm) Type X Gypsum Wallboard with a minimum weight of 3.0 lbf/ft² (14.6 kg/m²) in compliance with ASTM C1396. Installed with long dimension perpendicular to resilient channels and fastened with min. 1-1/8-inch (29-mm) Type S drywall screws spaced at 8 inches (203 mm) on center, and 1 inch (25 mm) from wallboard edges and 1-1/2 inches (38 mm) from wallboard ends. The end joints of the wallboard must be staggered.
 - a) Finish: The face joints must be covered with tape and coated with joint compound. Screw heads must also be covered with joint compound.

B. SOUND RATING^(a)

Components	STC	IIC
Base Assembly with cushioned vinyl	52	44
Base Assembly with Carpet and Padding	52	64
Base Assembly with cushioned vinyl, Gypsum Concrete	64	53
Base Assembly with Carpet and Padding, Gypsum Concrete	64	68

^(a) Sound ratings determined from engineering analysis using AWC Technical Report 15, Calculation of Sound Transmission Parameters for Wood-Frame Assemblies in accordance with Section 1206.2 of the 2018/2021 IBC.

C. SIMILAR ASSEMBLIES

- 1) Assemblies that meet the fire-resistance rating in accordance with NBC Table 9.10.3.1.-B or the calculation method specified in NBC Appendix D-2.3.

* This assembly may also be used in a fire-rated roof/ceiling assembly, but only when constructed exactly as described.

† Authorization for use by APA – The Engineered Wood Association.

REPRESENTING THE ENGINEERED WOOD INDUSTRY



Pacific Woodtech Corporation Assembly PWI2.1

Two-Hour Fire Resistance Rated Floor/Ceiling Assembly*

This fire resistance design is listed in accordance with the International Building Code (IBC) and

American Wood Council's Design for Code Acceptance (DCA) 3

Min. 9-1/4 inches (235 mm) Deep: LPI 18/PWI 18S, LPI 20Plus/PWI 20S, LPI 32Plus/PWI 32S, LPI 36/PWI 36L, LPI 42Plus/PWI 42S, LPI 52Plus/PWI 52S, and LPI 56/PWI 56L I-Joists

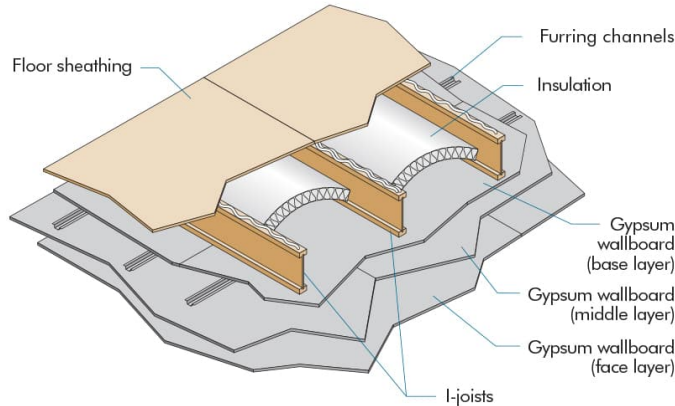

A. BASIC ASSEMBLIES

- 1) Floor Topping (Optional): Varies (reference sound ratings if applicable).
- 2) Floor Sheathing: Min. 23/32-inch (18-mm) T&G Wood Structural Panel. The sheets shall be installed with their long edge perpendicular to the joists with end joints centered over the top flange of joists. Floor sheathing must be installed per code requirements.
- 3) Insulation: Min. 3-1/2-inch (89-mm) Unfaced Glass Fiber Insulation. Friction fitted between I-joists and supported by stay wires spaced 12 inches (305 mm) on center along the top of the I-joist bottom flange.
- 4) Structural Members: Min. 9-1/4 inches (235 mm) Deep I-Joists. Max. 24 inches (610 mm) on center spacing. Min. flange thickness of 1-1/2 inches (38 mm) and each flange area of at least 2.25 inches² (1,452 mm²). Min. web thickness of 3/8 inch (9.5 mm).
- 5) Furring Channels: Min. 0.0179-inch (0.45-mm) Hat Shaped Galvanized Steel Channels attached perpendicular to the bottom flange of the I-joist with 1-5/8-inch (41-mm) Type S drywall screws penetrating through the wallboard base layer into each I-joist flange. Channels are spaced a max. of 16 inches (406 mm) on center, are doubled at each base layer wallboard end joint, and extend to the next joist beyond each joint.
- 6) Ceiling: Three layers of 5/8-inch (16-mm) Type C Gypsum Wallboard.
 - a) Base Layer: Install with long dimension perpendicular to joist length. Attach to the bottom flange of the joists using 1-5/8-inch (41-mm) Type S drywall screws at 12 inches (305 mm) on center. The end joints of the wallboard must be centered on the bottom flange of the I-joist and must be staggered.
 - b) Middle Layer: Attached to furring channels using 1-inch (25-mm) Type S drywall screws at 12 inches (305 mm) on center with the long dimension perpendicular to furring channels. End joints must be staggered from end joints of adjacent sheets and end joints on the face layer.
 - c) Face Layer: Attached to furring channels through the middle layer using 1-5/8-inch (41-mm) Type S drywall screws spaced at 8 inches (203 mm) on center with long dimension perpendicular to furring channel. End joints must be staggered from end joints of adjacent sheets and staggered from end joints on the middle layer. Edge joints (long dimension) must be offset 24 inches (610 mm) from those of the middle layer.
 - d) Finish: The face layer joints must be covered with tape and coated with joint compound. Screw heads must also be covered with joint compound.

B. SOUND RATING^(a,b)

Joist/RC Spacing	Without Gypsum Concrete				With 1-in. (25-mm) Gypsum Concrete			
	Cushioned Vinyl		Carpet & Pad		Cushioned Vinyl		Carpet & Pad	
	STC	IIC	STC	IIC	STC	IIC	STC	IIC
24"/16" o.c.	--	--	49	54	58	45	58	64

^(a) Sound ratings from the American Wood Council publication Design for Code Acceptance (DCA) 3, available from www.awc.org/.

^(b) STC and IIC values are based on engineering analysis performed by David L. Adams Associates, Inc.

C. SIMILAR ASSEMBLIES

- 1) 2012/2015/2018/2021 IBC Table 721.1(3) Item 28-1.1, and DCA 3 WIJ-2.1.
- 2) Assemblies that meet the fire-resistance rating in accordance with NBC Table 9.10.3.1.-B or the calculation method specified in NBC Appendix D-2.3.

* This assembly may also be used in a fire-rated roof/ceiling assembly, but only when constructed exactly as described.

REPRESENTING THE ENGINEERED WOOD INDUSTRY



Fire Protection of Floors (FP-11) for Compliance with 2012 IRC Section R501.3 and 2015, 2018 and 2021 IRC Section R302.13

Fire Protection: 7/16 or Thicker Wood Structural Panel for Web Protection

The following fire resistance design is an alternative to the 2-by-10 dimensional lumber prescribed in 2012 IRC Section R501.3 and 2015/2018/2021 IRC Section R302.13 Exception 4, with demonstrated equivalent fire performance

Min. 9-1/2 inches (241 mm) Deep: LPI 18/PWI 18S, LPI 20Plus/PWI 20S, LPI 32Plus/PWI 32S, LPI 42Plus/PWI 42S, LPI 52Plus/PWI 52S, and LPI 56/PWI 56L I-Joists

7/16 in. (11 mm) or Thicker Wood Structural Panel for Web Protection ^(a,b,d)

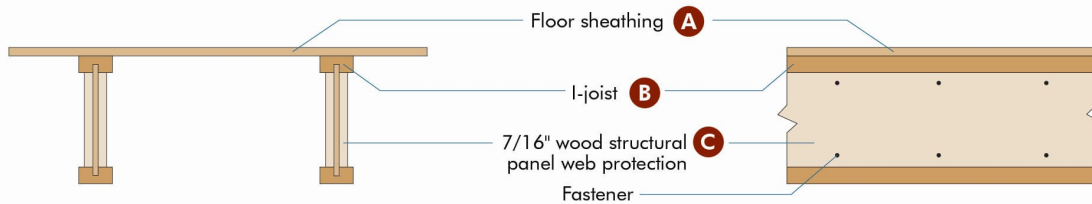

Installation Requirements at Web Holes

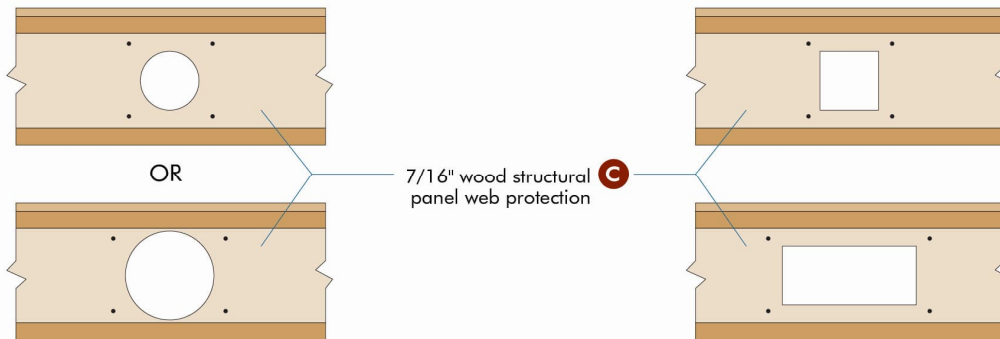

Crawl Space Exception^(b)

In accordance with Exception 2 of the 2012 IRC Section R501.3 and 2015/2018/2021 IRC Section R302.13, floor assemblies located directly over a crawl space not intended for storage or fuel-fired appliances do not require wood structural panel fire protection.

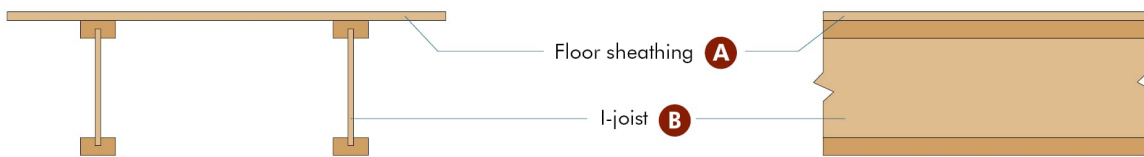

Automatic Sprinkler Exception^(c)

In accordance with Exception 1 of the 2012 IRC Section R501.3 and 2015/2018/2021 IRC Section R302.13, floor assemblies located directly over a space protected by an automatic sprinkler system do not require wood structural panel fire protection.

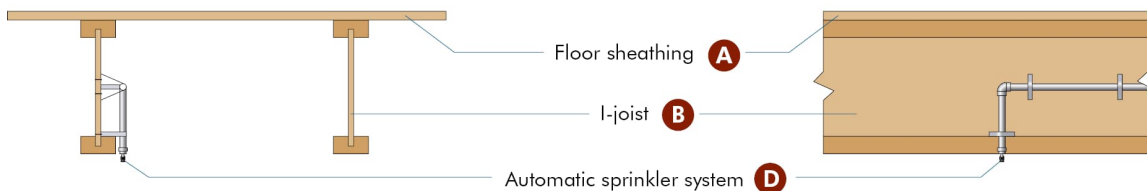

(Continued next page)

REPRESENTING THE ENGINEERED WOOD INDUSTRY



(FP-11 Continued)

- (A) Floor sheathing: Materials and installation in accordance with 2012, 2015, 2018, and 2021 IRC Section R503.
- (B) I-joist: Installation in accordance with Section 4.0 of this report. Maximum 24 inches (610 mm) on center spacing. Minimum flange size of 1-1/2 inches (38 mm) thick x 2-1/2 inches (63 mm) wide. Minimum web thickness of 3/8 inch (9.5 mm). Adhesives used shall be as described in the quality manual approved by APA. At each hole location, the 7/16 in. (11 mm) or thicker wood structural panels (WSP) shall be cut with the web hole on both sides of the I-joist to allow the passage of a wire, pipe, or duct, in accordance with the web hole requirements permitted in the I-joist product report.
- (C) Wood structural panel for web protection: Min. 7/16 Performance Category in compliance with DOC PS 1 or PS 2. The WSP shall continuously cover the entire length of the I-joist web on both sides. The panel-to-panel joints shall be tight with a joint gap of 1/16 inch (1.6 mm) or less and not required to be finished with tape or joint compound. Fasteners: Each WSP shall be fastened with 2 rows of 1/2 inch x 1 inch (12.7 mm x 25.4 mm) construction staples at 9 inches (229 mm) on center and 1 inch (25.4 mm) from the flange edge. Fasteners may be staggered from top to bottom. At hole location, fasteners shall be installed 1 inch (25.4 mm) from the edge of the hole, top and bottom.
- (D) Automatic sprinkler system: System in accordance with Section P2904 of the 2012, 2015, 2018 and 2021 IRC, NFPA 13D, or other equivalent sprinkler systems.

Notes:

- (a) In accordance with Exception 3 of 2012 IRC Section R501.3 and 2015/2018/2021 IRC Section R302.13, portions of floor assembly can be unprotected when complying with the following:
 - 1) The aggregate area of the unprotected portions shall not exceed 80 square feet (7.4 m²).
 - 2) Fire blocking in accordance with 2012, 2015, 2018, and 2021 IRC Section R302.11.1 shall be installed along the perimeter of the unprotected portion to separate the unprotected portion from the remainder of the floor assembly.
- (b) Insulation may be required for energy code compliance purposes. Check with the local building official for specific jurisdictional requirements.
- (c) In accordance with 2012, 2015, 2018, and 2021 IRC Section P2904, partial residential sprinkler systems are permitted to be installed only when the entire dwelling unit is not required to be equipped with a residential sprinkler system. Check with the local building official for specific jurisdictional requirements.
- (d) Penetrations or openings for ducts, vents, electrical outlets, lighting, devices, luminaires, wires, speakers, drainage, piping and similar openings or penetrations shall be permitted.



Pacific Woodtech Corporation Assembly RB1
Fire Resistance Rated Rim Board Assembly

The following fire resistance design is listed in accordance with ASTM E119 and CAN/ULC S101

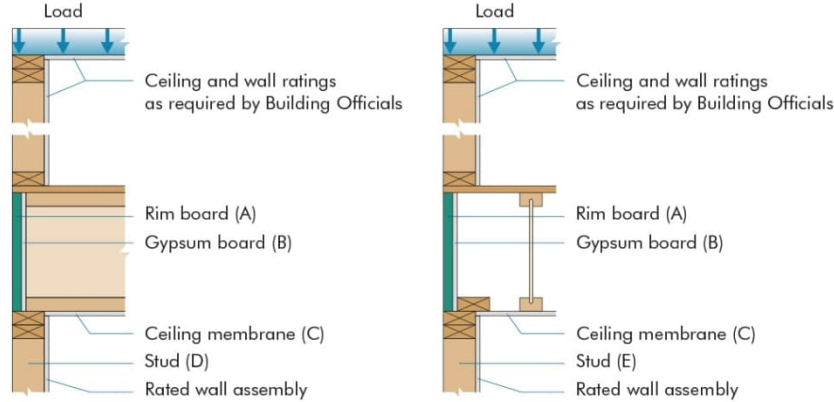

End Wall Configuration Base Assembly

Rim Board Thickness, in.	Rim Board Protection	Ceiling Membrane Req. for 1-hr	Ceiling Membrane Req. for 2-hr	Stud Size	Stud Size
A	B	C	C	D	E
1-1/4	Unprotected	1-hour Fire-rated Assembly	2-hour Fire-rated Assembly	2x4	2x4
	(1) 1/2" Type X	5/8" Type X	2-hour Fire-rated Assembly	2x4	2x4
	(1) 5/8" Type X	5/8" Type X	90-min Fire-rated Assembly	2x6	2x4
	(2) 1/2" Type X	No Ceiling Required	1-hour Fire-rated Assembly	2x6	2x4
	(2) 5/8" Type X	No Ceiling Required	5/8" Type X	2x6	2x4
1-1/2	Unprotected	1-hour Fire-rated Assembly	2-hour Fire-rated Assembly	2x4	2x4
	(1) 1/2" Type X	5/8" Regular	90-min Fire-rated Assembly	2x6	2x4
	(1) 5/8" Type X	1/2" Type X	90-min Fire-rated Assembly	2x6	2x4
	(2) 1/2" Type X	No Ceiling Required	1-hour Fire-rated Assembly	2x6	2x4
	(2) 5/8" Type X	No Ceiling Required	5/8" Type X	2x6	2x6
1-3/4	Unprotected	1-hour Fire-rated Assembly	2-hour Fire-rated Assembly	2x4	2x4
	(1) 1/2" Type X	5/8" Regular	90-min Fire-rated Assembly	2x6	2x4
	(1) 5/8" Type X	1/2" Type X	90-min Fire-rated Assembly	2x6	2x4
	(2) 1/2" Type X	No Ceiling Required	45-min Fire-rated Assembly	2x6	2x6
	(2) 5/8" Type X	No Ceiling Required	5/8" Type X	2x6	2x6

- 1) Rim assembly for fire from inside of structure.
- 2) Gypsum wallboard shown on the ceiling is to protect the Rim Board only. It does not necessarily cause the floor assembly to be rated.
- 3) Attach 1-layer Type X (1/2 or 5/8-inch) gypsum wallboard to Rim Board with 1-1/2-inch Type W drywall screws spaced 12 inches o.c.
- 4) Attach 2-layer Type X (1/2 or 5/8-inch) gypsum wallboards to Rim Board with 2-inch Type W drywall screws spaced 12 inches o.c.
- 5) Provide min. 1-3/4-inch bearing for I-joist.
- 6) Use only fire rated gypsum wallboard. Type C may be substituted for Type X.
- 7) Rim Board and gypsum wallboard thickness are shown as minimums. Thicker Rim Board and gypsum wallboard may be substituted.
- 8) When 2-layer gypsum wallboards are used, I-joist end nails shall be 16d box (0.135 inch x 3-1/2 inches) nails.
- 9) Rim board shall be sized for vertical and lateral loads.
- 10) Stud size may be reduced if the gypsum protection is discontinuous, provided that other requirements in the code are satisfied.

REPRESENTING THE ENGINEERED WOOD INDUSTRY



Pacific Woodtech Corporation Assembly RB2
Fire Resistance Rated Rim Board Assembly

The following fire resistance design is listed in accordance with ASTM E119 and CAN/ULC S101

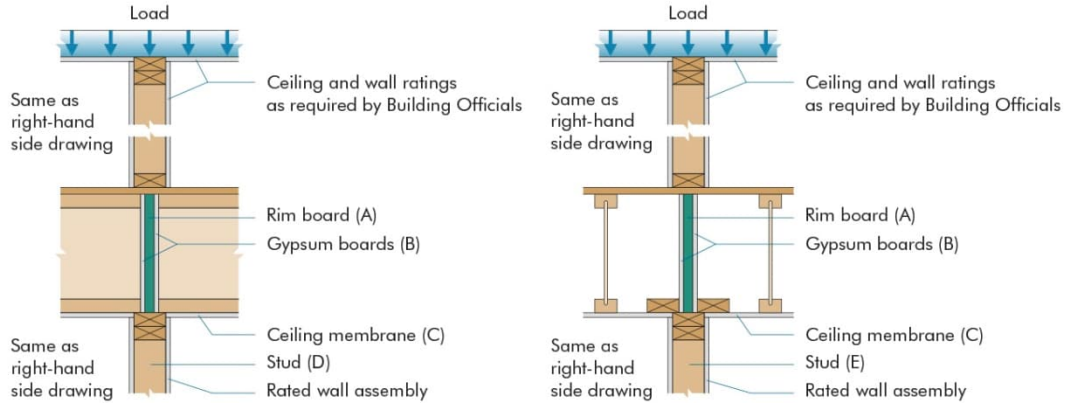

Single Wall Configuration Base Assembly

Rim Board Thickness, in.	Rim Board Protection	Ceiling Membrane Req. for 1-hr	Ceiling Membrane Req. for 2-hr	Stud Size	Stud Size
A	B	C	C	D	E
1-1/4	Unprotected	5/8" Type X	2-hour Fire-rated Assembly	2x6	2x4
	(1) 1/2" Type X	1/2" Regular	90-min Fire-rated Assembly	2x8	2x6
	(1) 5/8" Type X	1/2" Regular	90-min Fire-rated Assembly	2x8	2x6
	(2) 1/2" Type X	No Ceiling Required	1/2" Type X	2x8	2x6
	(2) 5/8" Type X	No Ceiling Required	1/2" Regular	2x8	2x6
1-1/2	Unprotected	5/8" Type X	2-hour Fire-rated Assembly	2x6	2x4
	(1) 1/2" Type X	1/2" Regular	90-min Fire-rated Assembly	2x8	2x6
	(1) 5/8" Type X	No Ceiling Required	1-hour Fire-rated Assembly	2x8	2x6
	(2) 1/2" Type X	No Ceiling Required	1/2" Type X	2x8	2x6
	(2) 5/8" Type X	No Ceiling Required	1/2" Regular	2x10	2x8
1-3/4	Unprotected	5/8" Regular	90-min Fire-rated Assembly	2x6	2x4
	(1) 1/2" Type X	1/2" Type X	90-min Fire-rated Assembly	2x8	2x6
	(1) 5/8" Type X	No Ceiling Required	1-hour Fire-rated Assembly	2x8	2x6
	(2) 1/2" Type X	No Ceiling Required	1/2" Regular	2x8	2x6
	(2) 5/8" Type X	No Ceiling Required	No Ceiling Required	2x10	2x8

- 1) Rim assembly for fire from either side of wall.
- 2) Gypsum wallboard shown on the ceiling is to protect the Rim Board only. It does not necessarily cause the floor assembly to be rated.
- 3) Attach 1-layer Type X (1/2 or 5/8-inch) gypsum wallboard to Rim Board with 1-1/2-inch Type W drywall screws spaced 12 inches o.c.
- 4) Attach 2-layer Type X (1/2 or 5/8-inch) gypsum wallboards to Rim Board with 2-inch Type W drywall screws spaced 12 inches o.c.
- 5) Provide min. 1-3/4-inch bearing for I-joist.
- 6) Use only fire rated gypsum wallboard. Type C may be substituted for Type X.
- 7) Rim Board and gypsum wallboard thickness are shown as minimums. Thicker Rim Board and gypsum wallboard may be substituted.
- 8) Toe nailing from the I-joist flange to the rim is permitted. When 2-layer (or more) gypsum wallboards are used, I-joist end nails shall be 16d box (0.135 inch x 3-1/2 inches) nails.
- 9) Rim board shall be sized for vertical and lateral loads.
- 10) Stud size may be reduced if the gypsum protection is discontinuous, provided that other requirements in the code are satisfied.

REPRESENTING THE ENGINEERED WOOD INDUSTRY



Pacific Woodtech Corporation Assembly RB3
Fire Resistance Rated Rim Board Assembly

The following fire resistance design is listed in accordance with ASTM E119 and CAN/ULC S101

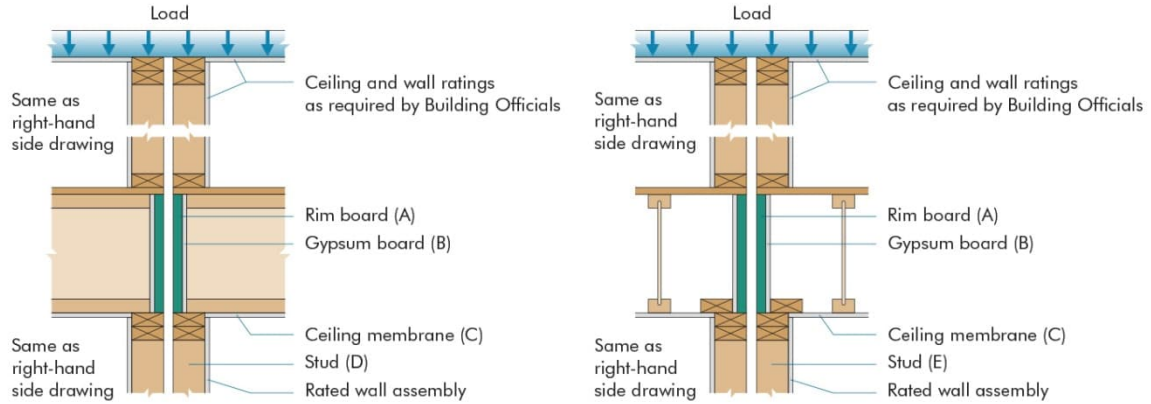

Double Wall Configuration with Load Transfer Base Assembly

Rim Board Thickness, in.	Rim Board Protection	Ceiling Membrane Req. for 1-hr	Ceiling Membrane Req. for 2-hr	Stud Size	Stud Size
A	B	C	C	D	E
1-1/4	Unprotected	1/2" Regular	90 min Fire-rated Assembly	2x4	2x4
	(1) 1/2" Type X	No Ceiling Required	45-min Fire-rated Assembly	2x4	2x4
	(1) 5/8" Type X	No Ceiling Required	5/8" Regular	2x6	2x4
	(2) 1/2" Type X	No Ceiling Required	No Ceiling Required	2x6	2x4
	(2) 5/8" Type X	No Ceiling Required	No Ceiling Required	2x6	2x4
1-1/2	Unprotected	No Ceiling Required	1-hour Fire-rated Assembly	2x4	2x4
	(1) 1/2" Type X	No Ceiling Required	5/8" Type X	2x6	2x4
	(1) 5/8" Type X	No Ceiling Required	1/2" Regular	2x6	2x4
	(2) 1/2" Type X	No Ceiling Required	No Ceiling Required	2x6	2x4
	(2) 5/8" Type X	No Ceiling Required	No Ceiling Required	2x6	2x6
1-3/4	Unprotected	No Ceiling Required	1-hour Fire-rated Assembly	2x4	2x4
	(1) 1/2" Type X	No Ceiling Required	1/2" Type X	2x6	2x4
	(1) 5/8" Type X	No Ceiling Required	No Ceiling Required	2x6	2x4
	(2) 1/2" Type X	No Ceiling Required	No Ceiling Required	2x6	2x6
	(2) 5/8" Type X	No Ceiling Required	No Ceiling Required	2x6	2x6

- 1) Rim assembly for fire from either side of wall. "With load transfer" assumes load transfers to the adjacent rim board if the fire exposed rim board fails.
- 2) Gypsum wallboard shown on the ceiling is to protect the Rim Board only. It does not necessarily cause the floor assembly to be rated.
- 3) Attach 1-layer Type X (1/2 or 5/8-inch) gypsum wallboard to Rim Board with 1-1/2-inch Type W drywall screws spaced 12 inches o.c.
- 4) Attach 2-layer Type X (1/2 or 5/8-inch) gypsum wallboards to Rim Board with 2-inch Type W drywall screws spaced 12 inches o.c.
- 5) Provide min. 1-3/4-inch bearing for I-joist.
- 6) Use only fire rated gypsum wallboard. Type C may be substituted for Type X.
- 7) Rim Board and gypsum wallboard thickness are shown as minimums. Thicker Rim Board and gypsum wallboard may be substituted.
- 8) Toe nailing from the I-joist flange to the rim is permitted. When 2-layer gypsum wallboards are used, I-joist end nails shall be 16d box (0.135 inch x 3-1/2 inches) nails.
- 9) Rim board shall be sized for vertical and lateral loads.
- 10) Stud size may be reduced if the gypsum protection is discontinuous, provided that other requirements in the code are satisfied.

REPRESENTING THE ENGINEERED WOOD INDUSTRY

Pacific Woodtech Corporation Assembly RB4 Fire Resistance Rated Rim Board Assembly

The following fire resistance design is listed in accordance with ASTM E119 and CAN/ULC S101

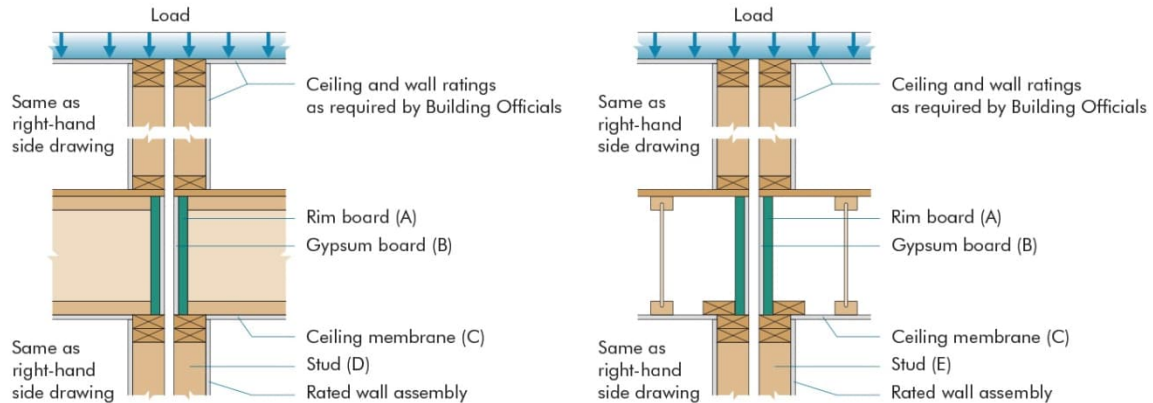

Double Wall Configuration with Load Transfer Base Assembly

Rim Board Thickness, in.	Rim Board Protection	Ceiling Membrane Req. for 1-hr	Ceiling Membrane Req. for 2-hr	Stud Size	Stud Size
A	B	C	C	D	E
1-1/4	Unprotected	1/2" Regular	90 min Fire-rated Assembly	2x4	2x4
	(1) 1/2" Type X	No Ceiling Required	1-hour Fire-rated Assembly	2x4	2x4
	(1) 5/8" Type X	No Ceiling Required	45-min Fire-rated Assembly	2x6	2x4
	(2) 1/2" Type X	No Ceiling Required	1/2" Regular	2x6	2x4
1-1/2	(2) 5/8" Type X	No Ceiling Required	No Ceiling Required	2x6	2x4
	Unprotected	No Ceiling Required	1-hour Fire-rated Assembly	2x4	2x4
	(1) 1/2" Type X	No Ceiling Required	5/8" Type X	2x6	2x4
	(1) 5/8" Type X	No Ceiling Required	5/8" Regular	2x6	2x4
1-3/4	(2) 1/2" Type X	No Ceiling Required	No Ceiling Required	2x6	2x4
	(2) 5/8" Type X	No Ceiling Required	No Ceiling Required	2x6	2x6
	Unprotected	No Ceiling Required	1-hour Fire-rated Assembly	2x4	2x4
	(1) 1/2" Type X	No Ceiling Required	1/2" Type X	2x6	2x4
1-3/4	(1) 5/8" Type X	No Ceiling Required	1/2" Regular	2x6	2x4
	(2) 1/2" Type X	No Ceiling Required	No Ceiling Required	2x6	2x6
1-3/4	(2) 5/8" Type X	No Ceiling Required	No Ceiling Required	2x6	2x6

- 1) Rim assembly for fire from either side of wall. "With load transfer" assumes load transfers to the adjacent rim board if the fire exposed rim board fails.
- 2) Gypsum wallboard shown on the ceiling is to protect the Rim Board only. It does not necessarily cause the floor assembly to be rated.
- 3) Attach 1-layer Type X (1/2 or 5/8-inch) gypsum wallboard to Rim Board with 1-1/2-inch Type W drywall screws spaced 12 inches o.c.
- 4) Attach 2-layer Type X (1/2 or 5/8-inch) gypsum wallboards to Rim Board with 2-inch Type W drywall screws spaced 12 inches o.c.
- 5) Provide min. 1-3/4-inch bearing for I-joist.
- 6) Use only fire rated gypsum wallboard. Type C may be substituted for Type X.
- 7) Rim Board and gypsum wallboard thickness are shown as minimums. Thicker Rim Board and gypsum wallboard may be substituted.
- 8) Toe nailing from the I-joist flange to the rim is permitted. When 2-layer gypsum wallboards are used, I-joist end nails shall be 16d box (0.135 inch x 3-1/2 inches) nails.
- 9) Rim board shall be sized for vertical and lateral loads.
- 10) Stud size may be reduced if the gypsum protection is discontinuous, provided that other requirements in the code are satisfied.

Pacific Woodtech Corporation Assembly RB5 Fire Resistance Rated Rim Board Assembly

The following fire resistance design is listed in accordance with ASTM E119 and CAN/ULC S101

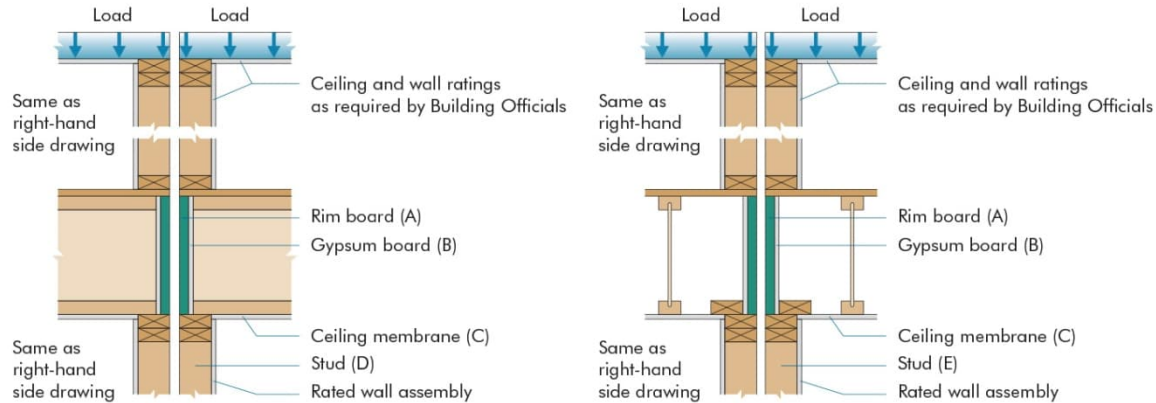

Double Wall Configuration with No Load Transfer Base Assembly

Rim Board Thickness, in.	Rim Board Protection	Ceiling Membrane Req. for 1-hr	Ceiling Membrane Req. for 2-hr	Stud Size	Stud Size
A	B	C	C	D	E
1-1/4	Unprotected	5/8" Type X	2-hour Fire-rated Assembly	2x4	2x4
	(1) 1/2" Type X	1/2" Regular	90-min Fire-rated Assembly	2x4	2x4
	(1) 5/8" Type X	1/2" Regular	90-min Fire-rated Assembly	2x6	2x4
	(2) 1/2" Type X	No Ceiling Required	5/8" Regular	2x6	2x4
	(2) 5/8" Type X	No Ceiling Required	1/2" Regular	2x6	2x4
1-1/2	Unprotected	1/2" Type X	90-min Fire-rated Assembly	2x4	2x4
	(1) 1/2" Type X	1/2" Regular	90-min Fire-rated Assembly	2x6	2x4
	(1) 5/8" Type X	No Ceiling Required	1-hour Fire-rated Assembly	2x6	2x4
	(2) 1/2" Type X	No Ceiling Required	1/2" Type X	2x6	2x4
	(2) 5/8" Type X	No Ceiling Required	1/2" Regular	2x6	2x6
1-3/4	Unprotected	1/2" Type X	90-min Fire-rated Assembly	2x4	2x4
	(1) 1/2" Type X	No Ceiling Required	1-hour Fire-rated Assembly	2x6	2x4
	(1) 5/8" Type X	No Ceiling Required	1-hour Fire-rated Assembly	2x6	2x4
	(2) 1/2" Type X	No Ceiling Required	1/2" Regular	2x6	2x6
	(2) 5/8" Type X	No Ceiling Required	No Ceiling Required	2x6	2x6

- 1) Rim assembly for fire from either side of wall. "With no load transfer" assumes no load transfers to the adjacent rim board if the fire exposed rim board fails.
- 2) Gypsum wallboard shown on the ceiling is to protect the Rim Board only. It does not necessarily cause the floor assembly to be rated.
- 3) Attach 1-layer Type X (1/2 or 5/8-inch) gypsum wallboard to Rim Board with 1-1/2-inch Type W drywall screws spaced 12 inches o.c.
- 4) Attach 2-layer Type X (1/2 or 5/8-inch) gypsum wallboards to Rim Board with 2-inch Type W drywall screws spaced 12 inches o.c.
- 5) Provide min. 1-3/4-inch bearing for I-joist.
- 6) Use only fire rated gypsum wallboard. Type C may be substituted for Type X.
- 7) Rim Board and gypsum wallboard thickness are shown as minimums. Thicker Rim Board and gypsum wallboard may be substituted.
- 8) Toe nailing from the I-joist flange to the rim is permitted. When 2 layer gypsum wallboards are used, I-joist end nails shall be 16d box (0.135 inch x 3-1/2 inches) nails.
- 9) Rim board shall be sized for vertical and lateral loads.
- 10) Stud size may be reduced if the gypsum protection is discontinuous, provided that other requirements in the code are satisfied.

Pacific Woodtech Corporation Assembly RB6 Fire Resistance Rated Rim Board Assembly

The following fire resistance design is listed in accordance with ASTM E119 and CAN/ULC S101

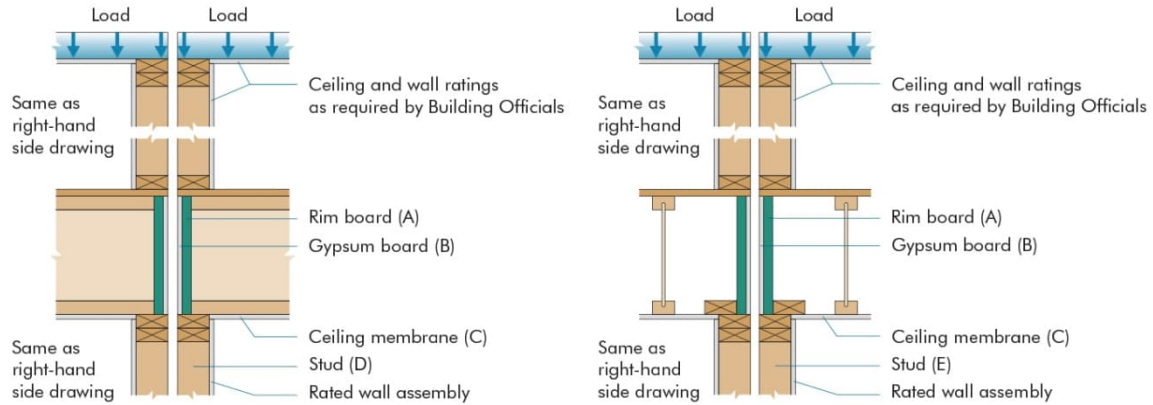

Double Wall Configuration with No Load Transfer Base Assembly

Rim Board Thickness, in.	Rim Board Protection	Ceiling Membrane Req. for 1-hr	Ceiling Membrane Req. for 2-hr	Stud Size	Stud Size
A	B	C	C	D	E
1-1/4	Unprotected	5/8" Type X	2-hour Fire-rated Assembly	2x4	2x4
	(1) 1/2" Type X	1/2" Regular	90-min Fire-rated Assembly	2x4	2x4
	(1) 5/8" Type X	No Ceiling Required	1-hour Fire-rated Assembly	2x6	2x4
	(2) 1/2" Type X	No Ceiling Required	1/2" Type X	2x6	2x4
	(2) 5/8" Type X	No Ceiling Required	1/2" Regular	2x6	2x4
1-1/2	Unprotected	1/2" Type X	90-min Fire-rated Assembly	2x4	2x4
	(1) 1/2" Type X	1/2" Regular	90-min Fire-rated Assembly	2x6	2x4
	(1) 5/8" Type X	No Ceiling Required	1-hour Fire-rated Assembly	2x6	2x4
	(2) 1/2" Type X	No Ceiling Required	1/2" Regular	2x6	2x4
	(2) 5/8" Type X	No Ceiling Required	No Ceiling Required	2x6	2x6
1-3/4	Unprotected	1/2" Type X	90-min Fire-rated Assembly	2x4	2x4
	(1) 1/2" Type X	No Ceiling Required	1-hour Fire-rated Assembly	2x6	2x4
	(1) 5/8" Type X	No Ceiling Required	45-min Fire-rated Assembly	2x6	2x4
	(2) 1/2" Type X	No Ceiling Required	No Ceiling Required	2x6	2x6
	(2) 5/8" Type X	No Ceiling Required	No Ceiling Required	2x6	2x6

- 1) Rim assembly for fire from either side of wall. "With no load transfer" assumes no load transfers to the adjacent rim board if the fire exposed rim board fails.
- 2) Gypsum wallboard shown on the ceiling is to protect the Rim Board only. It does not necessarily cause the floor assembly to be rated.
- 3) Attach 1-layer Type X (1/2 or 5/8-inch) gypsum wallboard to Rim Board with 1-1/2-inch Type W drywall screws spaced 12 inches o.c.
- 4) Attach 2-layer Type X (1/2 or 5/8-inch) gypsum wallboards to Rim Board with 2-inch Type W drywall screws spaced 12 inches o.c.
- 5) Provide min. 1-3/4-inch bearing for I-joist.
- 6) Use only fire rated gypsum wallboard. Type C may be substituted for Type X.
- 7) Rim Board and gypsum wallboard thickness are shown as minimums. Thicker Rim Board and gypsum wallboard may be substituted.
- 8) Toe nailing from the I-joist flange to the rim is permitted. When 2-layer gypsum wallboards are used, I-joist end nails shall be 16d box (0.135 inch x 3-1/2 inches) nails.
- 9) Rim board shall be sized for vertical and lateral load.
- 10) Stud size may be reduced if the gypsum protection is discontinuous, provided that other requirements in the code are satisfied.

APA – The Engineered Wood Association is an approved national standards developer accredited by American National Standards Institute (ANSI). APA publishes ANSI standards and Voluntary Product Standards for wood structural panels and engineered wood products. APA is an accredited certification body under ISO/IEC 17065 by Standards Council of Canada (SCC), an accredited inspection agency under ISO/IEC 17020 by International Code Council (ICC) International Accreditation Service (IAS), and an accredited testing organization under ISO/IEC 17025 by IAS. APA is also an approved Product Certification Agency, Testing Laboratory, Quality Assurance Entity, Validation Entity, and Product Evaluation Entity by the State of Florida, and an approved testing laboratory by City of Los Angeles.

**APA – THE ENGINEERED WOOD ASSOCIATION
HEADQUARTERS**

7011 So. 19th St. • Tacoma, Washington 98466
Phone: (253) 565-6600 • Fax: (253) 565-7265 • Internet Address: www.apawood.org

PRODUCT SUPPORT HELP DESK
(253) 620-7400 • E-mail Address: help@apawood.org

DISCLAIMER

APA Product Report® is a trademark of *APA – The Engineered Wood Association*, Tacoma, Washington. The information contained herein is based on the product evaluation in accordance with the references noted in this report. Neither APA, nor its members make any warranty, expressed or implied, or assume any legal liability or responsibility for the use, application of, and/or reference to opinions, findings, conclusions, or recommendations included in this report. Consult your local jurisdiction or design professional to assure compliance with code, construction, and performance requirements. Because APA has no control over quality of workmanship or the conditions under which engineered wood products are used, it cannot accept responsibility for product performance or designs as actually constructed.