



# TECH GUIDE

- | PWI 18S
- | PWI 20S
- | PWI 32S
- | PWI 42S

## PWT I-JOIST

---

RESIDENTIAL  
CONSTRUCTION

---

**PWT** FOCUSED ON EWP





PWT™ I-Joists are straighter and more uniform in strength, stiffness and size than traditional lumber, providing a strong, sturdy floor. We offer longer lengths so that ceilings and floors can be designed with fewer pieces, saving time on installation. Other advantages over lumber include lower moisture content, which makes our I-Joists less likely to split, shrink, twist, warp or bow. This means reduced callbacks due to fewer pops and squeaks.

## Strength in Numbers

The full range of PWT products are designed and manufactured to install easily and work together to provide a strong, sound structure.

For I-Joists, we combine laminated veneer lumber (LVL) or finger-jointed sawn lumber flanges with a web of oriented strand board (OSB) to produce an I-shaped structural member. The webs allow plumbing and wiring to pass through without extra framing, while the flanges resist bending – ideal for long spans in floors, ceilings and roofs.

PWT I-Joists are a building material with built-in environmental benefits

- Made of wood, a renewable resource
- Raw material procurement targets small, fast growing trees
- Only low-emitting, safe resins are used as a binder
- Available in longer lengths, reducing the number of pieces needed; this results in more efficient utilization of resources
- Can help you qualify for certification points in a number of leading green building programs

## Peace-of-Mind for a Lifetime

If your PWT I-Joists ever develop performance problems due a manufacturing defect, PWT will cover all reasonable repair and/or replacement costs per the conditions of our Lifetime Limited Warranty. Visit [pwtewp.com](http://pwtewp.com) to view our complete warranty, or contact your local PWT distributor or sales office for an original copy.

## Compliant with Major Building Codes

PWT I-Joists have been evaluated for compliance with major US building codes. Refer to APA product report PR-L238 or ICC-ES evaluation report ESR-1305 for complete product information for PWT I-Joist. Contact your local PWT distributor or visit [pwtewp.com](http://pwtewp.com) for the most current code reports.

## Lifetime Limited Warranty

PWT products are backed by a lifetime limited warranty. Visit [pwtewp.com](http://pwtewp.com) or call (800) 515-7570 for a copy of the warranty.

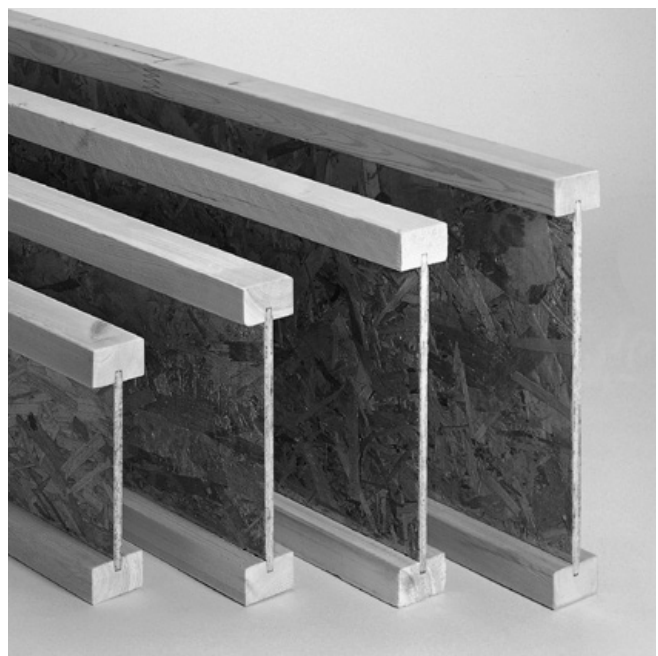



# Solid-Sawn I-Joists

**PWI 18S, LPI 18**

Width: 2-1/2"

Depths: 9-1/2", 11-7/8"

Web Thickness: 3/8"

Flange Material: Solid Sawn

Flange Depth: 1-1/2"

**PWI 20S & PWI 32S, LPI 20Plus & LPI 32Plus**

Width: 2-1/2"

Depths: 9-1/2", 11-7/8", 14", 16"

Web Thickness: 3/8"

Flange Material: Solid Sawn

Flange Depth: 1-1/2"

**PWI 42S, LPI 42Plus**

Width: 3-1/2"

Depths: 11-7/8", 14", 16"

Web Thickness: 3/8"

Flange Material: Solid Sawn

Flange Depth: 1-1/2"

**Code Evaluation Reports:**  
ICC ESR-1305, APA PR-L238  
or visit [pwtewp.com](http://pwtewp.com)

# Product Specifications & Design Values

## DESIGN VALUES

Series	Depth	Weight (plf)	Moment (lb-ft)	EI (x 10 <sup>6</sup> ) (lb-in <sup>2</sup> )	K (x 10 <sup>6</sup> ) (lb-ft/in)	Shear (lbs)
PWI 18S, LPI 18	9-1/2"	2.6	2365	142	0.355	1130
	11-7/8"	2.9	3100	248	0.435	1335
PWI 20S, LPI 20Plus	9-1/2"	2.6	2810	185	0.358	1260
	11-7/8"	2.9	3755	318	0.438	1485
	14"	3.1	4400	474	0.512	1680
PWI 32S, LPI 32Plus	9-1/2"	2.6	3620	243	0.213	1260
	11-7/8"	2.9	4690	406	0.267	1485
	14"	3.1	5645	589	0.313	1680
PWI 42S, LPI 42Plus	11-7/8"	3.5	6965	547	0.515	1625
	14"	3.8	8390	802	0.607	1875
	16"	4	9725	1092	0.693	2115

### Notes:

- PWT™ I-Joists shall be designed for dry-use conditions only. Dry-use applies to products installed in dry, covered and well ventilated interior conditions in which the equivalent moisture content in lumber will not exceed 16%.
- Moment and Shear are for normal load duration and shall be adjusted according to code.
- Moment shall not be increased for repetitive member use.
- Deflection calculations shall include both bending and shear deformations.

Deflection for a simple span, uniform load:

$$\Delta = \frac{22.5wL^4}{EI} + \frac{wL^2}{K}$$

Where:  $\Delta$  = deflection (in)      EI = bending stiffness (from table)  
 w = uniform load (plf)      K = shear stiffness (from table)  
 L = design span (ft)

Equations for other conditions can be found in engineering references.

## REACTION AND BEARING CAPACITY

Series	Depth	End Reaction Capacity <sup>1</sup> (lbs)				Interior Reaction Capacity <sup>1</sup> (lbs)				Flange Bearing Capacity <sup>2</sup> (lb/in)
		Minimum Bearing (1-1/2")		Maximum Bearing (4")		Minimum Bearing (3-1/2")		Maximum Bearing (5-1/2")		
		Without Stiffeners	With Stiffeners	Without Stiffeners	With Stiffeners	Without Stiffeners	With Stiffeners	Without Stiffeners	With Stiffeners	
PWI 18S, LPI 18	9-1/2"	870	1025	995	1130	1975	2135	2205	2370	955
	11-7/8"	870	1145	1040	1335	2095	2270	2335	2545	
PWI 20S, LPI 20Plus	9-1/2"	970	1140	1110	1260	2195	2375	2450	2635	955
	11-7/8"	970	1275	1160	1485	2330	2525	2595	2830	
	14"	970	1395	1200	1680	2455	2665	2725	3005	
PWI 32S, LPI 32Plus	9-1/2"	970	1140	1110	1260	2195	2375	2450	2635	1180
	11-7/8"	970	1275	1160	1485	2330	2525	2595	2830	
	14"	970	1395	1200	1680	2455	2665	2725	3005	
PWI 42S, LPI 42Plus	11-7/8"	1245	1510	1595	1625	3025	3340	3120	3515	1705
	14"	1300	1660	1595	1875	3140	3565	3280	3805	
	16"	1350	1800	1595	2115	3245	3775	3435	4080	

### Notes:

- End and Interior Reaction Capacity shall be limited by the Flange Bearing Capacity or the bearing capacity of the support material, whichever is less.
- The Flange Bearing Capacity, per inch of bearing length, is based on the allowable compression perpendicular-to-grain of the I-Joist flange, accounting for eased edges.
- To account for edge easing when determining the bearing capacity of the support material, subtract 0.25" from the flange width for the PWI 18S, LPI 18; PWI 20S, LPI 20Plus; PWI 32S, LPI 32Plus; and PWI 42S, LPI 42Plus.
- Reaction Capacity is for normal load duration and shall be adjusted according to code. Flange Bearing Capacity and the bearing capacity of any wood support shall not be adjusted for load duration.
- Reaction Capacity and Flange Bearing Capacity may be increased over that tabulated for the minimum bearing length. Linear interpolation of the Reaction Capacity between the minimum and maximum bearing length is permitted. Bearing lengths longer than the maximum do not further increase Reaction Capacity. Flange Bearing Capacity and that of a wood support will increase with additional bearing length.
- See page 20 for information on web stiffener sizes and nailing.

**Example:** Determine the stiffened end reaction capacity for a 14" PWI 32S with 2" of bearing for a non-snow roof load and supported on an SPF wall plate (425 psi).

- Determine End Reaction (ER) with Stiffeners:  $ER = 1395 + (1680 - 1395)(2 - 1.5)/(4 - 1.5) = 1448$  lbs
- Adjust for load duration: Adjusted ER =  $1448 * 1.25 = 1810$  lbs
- Determine Flange Bearing Capacity (FBC):  $FBC = 1180 \text{ lb/in} * 2" = 2360$  lbs
- Determine wall Plate Bearing Capacity (PBC):  $PBC = 425 \text{ psi} * (2.5" - 0.25") * 2" = 1912$  lbs
- Final End Reaction Capacity with Stiffeners = 1810 lbs

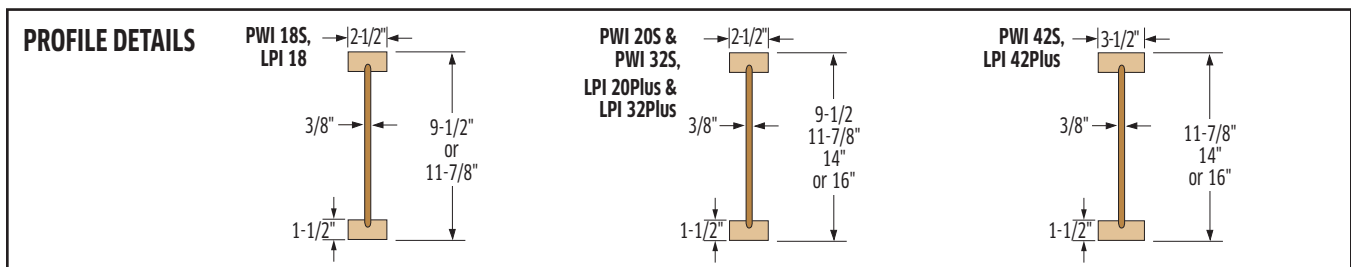

# Floor Span Tables

## Table Usage:

1. Select the Simple Span or Continuous Span table, as required.
2. Find a span that meets or exceeds the required clear span.
3. Read the corresponding joist series, depth and spacing.

**Caution:** For floor systems that require both simple span and continuous span joists, it is a good idea to check both before selecting a joist. Some conditions are controlled by continuous span rather than simple span.

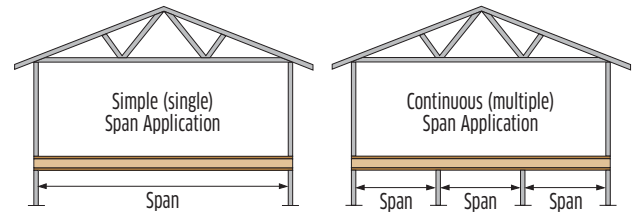

## 40 psf Live Load and 10 psf Dead Load

### SIMPLE SPAN 40/10 LOADING

Series	Depth	Simple Span							
		L/480				L/360			
		12" oc	16" oc	19.2" oc	24" oc	12" oc	16" oc	19.2" oc	24" oc
PWI 18S, LPI 18	9-1/2"	16'-6"	15'-2"	14'-4"	13'-4"	18'-3"	16'-8"	15'-3"	13'-7"
	11-7/8"	19'-9"	18'-1"	17'-1"	15'-7"	21'-10"	19'-1"	17'-5"	15'-7"
PWI 20S, LPI 20Plus	9-1/2"	17'-9"	16'-2"	15'-4"	14'-3"	19'-7"	17'-11"	16'-7"	14'-10"
	11-7/8"	21'-2"	19'-4"	18'-3"	17'-0"	23'-5"	21'-1"	19'-3"	17'-2"
	14"	24'-1"	22'-0"	20'-9"	18'-7"	26'-4"	22'-10"	20'-10"	18'-7"
PWI 32S, LPI 32Plus	9-1/2"	18'-9"	17'-0"	16'-0"	14'-9"	20'-10"	18'-11"	17'-10"	16'-6"
	11-7/8"	22'-3"	20'-2"	19'-0"	17'-7"	24'-9"	22'-6"	21'-2"	19'-2"
	14"	25'-2"	22'-10"	21'-6"	19'-6"	28'-0"	25'-5"	23'-7"	19'-6"
PWI 42S, LPI 42Plus	11-7/8"	27'-10"	25'-3"	23'-9"	19'-7"	30'-11"	27'-10"	24'-7"	19'-7"
	14"	24'-11"	22'-8"	21'-4"	19'-10"	27'-6"	25'-1"	23'-8"	22'-0"
	16"	28'-3"	25'-9"	24'-3"	22'-6"	31'-3"	28'-6"	26'-10"	25'-0"
	16"	31'-4"	28'-6"	26'-10"	25'-0"	34'-7"	31'-7"	29'-9"	26'-1"

### CONTINUOUS SPAN 40/10 LOADING

Series	Depth	Continuous Span							
		L/480				L/480 with Web Stiffeners			
		12" oc	16" oc	19.2" oc	24" oc	12" oc	16" oc	19.2" oc	24" oc
PWI 18S, LPI 18	9-1/2"	17'-11"	16'-5"	15'-2"	13'-6"	-	-	-	-
	11-7/8"	21'-6"	19'-0"	17'-4"	15'-6"	-	-	-	-
PWI 20S, LPI 20Plus	9-1/2"	19'-3"	17'-7"	16'-6"	14'-9"	-	-	-	-
	11-7/8"	23'-0"	21'-0"	19'-2"	17'-1"	-	-	-	-
	14"	26'-3"	22'-9"	20'-9"	18'-6"	-	-	-	-
PWI 32S, LPI 32Plus	9-1/2"	28'-2"	24'-4"	22'-3"	19'-10"	-	-	-	-
	11-7/8"	20'-4"	18'-5"	17'-3"	15'-11"	-	-	-	-
	14"	24'-2"	21'-10"	20'-6"	18'-5"	-	-	-	18'-11"
PWI 42S, LPI 42Plus	11-7/8"	27'-4"	24'-9"	23'-3"	19'-5"	-	-	-	21'-0"
	14"	30'-3"	27'-5"	25'-4"	20'-4"	-	-	-	22'-1"
	16"	27'-1"	24'-8"	23'-2"	21'-7"	-	-	-	-
	14"	30'-9"	28'-0"	26'-4"	23'-11"	-	-	-	24'-6"
	16"	34'-1"	31'-0"	29'-2"	24'-9"	-	-	-	27'-1"

## Design Assumptions:

1. The spans listed are the clear distance between supports. Continuous spans are based on the longest span. The shortest span shall not be less than 50% of the longest span.
2. The spans are based on uniform floor loads as listed at the top of this page. The dead load is increased to 12 psf for the PWI 42S and LPI 42Plus.
3. These tables reflect the additional stiffness provided by 48/24 APA RATED SHEATHING or 24 oc APA RATED STURD-I-FLOOR, or equal, glued and nailed to the top flange.
4. Live Load deflection is limited to L/480 or L/360 for simple spans as listed, and L/480 only for continuous spans.
5. Total Load deflection is limited to L/240.
6. The spans are based on an end bearing length of at least 1-3/4" and an interior bearing length of at least 3-1/2", and are limited to the bearing capacity for an SPF wall plate (F<sub>c1</sub> = 425 psi).

## Additional Notes:

1. Web stiffeners are not required for the Simple Span tables. Web stiffeners are not required at the end bearings for the Continuous Span tables. Web stiffeners at interior supports are only required where listed in the "With Web Stiffeners" section of each table. A "-" indicates no increase in span with web stiffeners.
2. Web fillers are required for I-Joists seated in hangers that do not laterally support the top flange.
3. L/360 represents the maximum deflection allowed per code and may not provide suitable floor performance. L/480 or better is recommended for most applications.
4. These spans are not evaluated for vibration.
5. Though not required for the spans above, bridging, blocking, bottom-flange bracing or a direct-applied gypsum ceiling can improve the feel of a floor.
6. For conditions not shown, use the Uniform Floor Load (PLF) tables, the Exacte by PWT software, or contact your PWT distributor for assistance.

# Floor Span Tables

## Table Usage:

1. Select the Simple Span or Continuous Span table, as required.
2. Find a span that meets or exceeds the required clear span.
3. Read the corresponding joist series, depth and spacing.

**Caution:** For floor systems that require both simple span and continuous span joists, it is a good idea to check both before selecting a joist. Some conditions are controlled by continuous span rather than simple span.

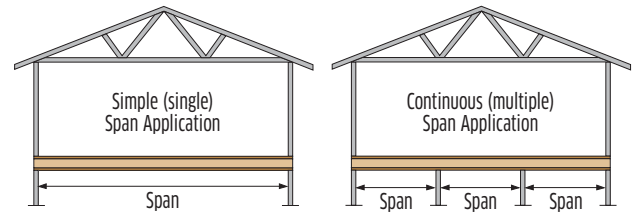

## 40 psf Live Load and 15 psf Dead Load

### SIMPLE SPAN 40/15 LOADING

Series	Depth	Simple Span							
		L/480				L/360			
		12" oc	16" oc	19.2" oc	24" oc	12" oc	16" oc	19.2" oc	24" oc
PWI 18S, LPI 18	9-1/2"	16'-6"	15'-2"	14'-4"	12'-11"	18'-3"	15'-11"	14'-6"	12'-11"
	11-7/8"	19'-9"	18'-1"	16'-7"	14'-10"	21'-1"	18'-3"	16'-7"	14'-10"
PWI 20S, LPI 20Plus	9-1/2"	17'-9"	16'-2"	15'-4"	14'-2"	19'-7"	17'-4"	15'-10"	14'-2"
	11-7/8"	21'-2"	19'-4"	18'-3"	16'-4"	23'-2"	20'-1"	18'-4"	16'-4"
	14"	24'-1"	21'-9"	19'-10"	17'-9"	25'-2"	21'-9"	19'-10"	17'-9"
PWI 32S, LPI 32Plus	9-1/2"	18'-9"	17'-0"	16'-0"	14'-9"	20'-10"	18'-11"	17'-10"	16'-1"
	11-7/8"	22'-3"	20'-2"	19'-0"	17'-7"	24'-9"	22'-5"	20'-6"	17'-8"
	14"	25'-2"	22'-10"	21'-6"	17'-9"	28'-0"	24'-8"	22'-3"	17'-9"
PWI 42S, LPI 42Plus	11-7/8"	27'-10"	25'-3"	22'-4"	17'-10"	30'-8"	26'-7"	22'-4"	17'-10"
	14"	24'-11"	22'-8"	21'-4"	19'-10"	27'-6"	25'-1"	23'-8"	22'-0"
	16"	28'-3"	25'-9"	24'-3"	22'-6"	31'-3"	28'-6"	26'-10"	23'-10"
	16"	31'-4"	28'-6"	26'-10"	24'-8"	34'-7"	31'-7"	29'-7"	24'-8"

### CONTINUOUS SPAN 40/15 LOADING

Series	Depth	Continuous Span							
		L/480				L/480 with Web Stiffeners			
		12" oc	16" oc	19.2" oc	24" oc	12" oc	16" oc	19.2" oc	24" oc
PWI 18S, LPI 18	9-1/2"	17'-11"	15'-10"	14'-5"	12'-10"	-	-	-	-
	11-7/8"	21'-0"	18'-2"	16'-6"	14'-9"	-	-	-	-
PWI 20S, LPI 20Plus	9-1/2"	19'-3"	17'-3"	15'-9"	14'-1"	-	-	-	-
	11-7/8"	23'-0"	20'-0"	18'-3"	16'-3"	-	-	-	-
	14"	25'-1"	21'-8"	19'-9"	17'-7"	-	-	-	17'-8"
PWI 32S, LPI 32Plus	16"	26'-10"	23'-3"	21'-2"	18'-5"	-	-	-	18'-11"
	9-1/2"	20'-4"	18'-5"	17'-3"	15'-9"	-	-	-	15'-11"
	11-7/8"	24'-2"	21'-10"	20'-5"	16'-8"	-	-	-	18'-1"
PWI 42S, LPI 42Plus	14"	27'-4"	24'-7"	22'-1"	17'-7"	-	-	22'-5"	19'-2"
	16"	30'-3"	26'-6"	23'-1"	18'-5"	-	-	24'-2"	20'-1"
	11-7/8"	27'-1"	24'-8"	23'-2"	21'-7"	-	-	-	-
	14"	30'-9"	28'-0"	26'-4"	22'-7"	-	-	-	24'-5"
	16"	34'-1"	31'-0"	29'-2"	23'-4"	-	-	-	26'-4"

#### Design Assumptions:

1. The spans listed are the clear distance between supports. Continuous spans are based on the longest span. The shortest span shall not be less than 50% of the longest span.
2. The spans are based on uniform floor loads as listed at the top of this page.
3. These tables reflect the additional stiffness provided by 48/24 APA RATED SHEATHING or 24 oc APA RATED STURD-I-FLOOR, or equal, glued and nailed to the top flange.
4. Live Load deflection is limited to L/480 or L/360 for simple spans as listed, and L/480 only for continuous spans.
5. Total Load deflection is limited to L/240.
6. The spans are based on an end bearing length of at least 1-3/4" and an interior bearing length of at least 3-1/2", and are limited to the bearing capacity for an SPF wall plate (F<sub>c1</sub> = 425 psi).

#### Additional Notes:

1. Web stiffeners are not required for the Simple Span tables. Web stiffeners are not required at the end bearings for the Continuous Span tables. Web stiffeners at interior supports are only required where listed in the "With Web Stiffeners" section of each table. A "-" indicates no increase in span with web stiffeners.
2. Web fillers are required for I-Joists seated in hangers that do not laterally support the top flange.
3. L/360 represents the maximum deflection allowed per code and may not provide suitable floor performance. L/480 or better is recommended for most applications.
4. These spans are not evaluated for vibration.
5. Though not required for the spans above, bridging, blocking, bottom-flange bracing or a direct-applied gypsum ceiling can improve the feel of a floor.
6. For conditions not shown, use the Uniform Floor Load (PLF) tables, the Exacte by PWT software, or contact your PWT distributor for assistance.

# Floor Span Tables

## Table Usage:

1. Select the Simple Span or Continuous Span table, as required.
2. Find a span that meets or exceeds the required clear span.
3. Read the corresponding joist series, depth and spacing.

**Caution:** For floor systems that require both simple span and continuous span joists, it is a good idea to check both before selecting a joist. Some conditions are controlled by continuous span rather than simple span.

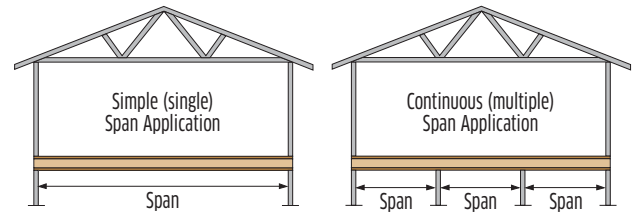

## 40 psf Live Load and 25 psf Dead Load

### SIMPLE SPAN 40/25 LOADING

Series	Depth	Simple Span							
		L/480				L/360			
		12" oc	16" oc	19.2" oc	24" oc	12" oc	16" oc	19.2" oc	24" oc
PWI 18S, LPI 18	9-1/2"	16'-6"	14'-7"	13'-4"	11'-11"	16'-11"	14'-7"	13'-4"	11'-11"
	11-7/8"	19'-4"	16'-9"	15'-3"	13'-4"	19'-4"	16'-9"	15'-3"	13'-4"
PWI 20S, LPI 20Plus	9-1/2"	17'-9"	15'-11"	14'-6"	13'-0"	18'-5"	15'-11"	14'-6"	13'-0"
	11-7/8"	21'-2"	18'-5"	16'-10"	14'-11"	21'-4"	18'-5"	16'-10"	14'-11"
	14"	23'-1"	20'-0"	18'-3"	14'-11"	23'-1"	20'-0"	18'-3"	14'-11"
PWI 32S, LPI 32Plus	9-1/2"	18'-9"	17'-0"	16'-0"	14'-9"	20'-3"	18'-1"	16'-6"	14'-9"
	11-7/8"	22'-3"	20'-2"	18'-8"	14'-11"	23'-10"	20'-8"	18'-8"	14'-11"
	14"	25'-2"	22'-7"	18'-9"	14'-11"	26'-2"	22'-7"	18'-9"	14'-11"
PWI 42S, LPI 42Plus	11-7/8"	24'-11"	22'-8"	21'-4"	19'-4"	26'-9"	24'-5"	23'-0"	19'-4"
	14"	28'-3"	25'-9"	24'-3"	20'-1"	30'-5"	27'-8"	25'-3"	20'-1"
	16"	31'-4"	28'-6"	26'-1"	20'-10"	33'-8"	29'-10"	26'-1"	20'-10"

### CONTINUOUS SPAN 40/25 LOADING

Series	Depth	Continuous Span							
		L/480				L/480 with Web Stiffeners			
		12" oc	16" oc	19.2" oc	24" oc	12" oc	16" oc	19.2" oc	24" oc
PWI 18S, LPI 18	9-1/2"	16'-10"	14'-6"	13'-3"	11'-10"	-	-	-	-
	11-7/8"	19'-3"	16'-8"	15'-2"	12'-8"	-	-	-	13'-7"
PWI 20S, LPI 20Plus	9-1/2"	18'-4"	15'-10"	14'-5"	12'-11"	-	-	-	-
	11-7/8"	21'-3"	18'-4"	16'-9"	14'-1"	-	-	-	14'-11"
	14"	23'-0"	19'-11"	18'-2"	14'-10"	-	-	-	16'-2"
PWI 32S, LPI 32Plus	9-1/2"	20'-4"	18'-0"	16'-5"	13'-3"	-	-	-	14'-4"
	11-7/8"	23'-9"	20'-7"	17'-8"	14'-1"	-	-	18'-9"	15'-3"
	14"	26'-1"	22'-5"	18'-8"	14'-10"	-	22'-7"	20'-3"	16'-2"
PWI 42S, LPI 42Plus	11-7/8"	27'-1"	24'-8"	22'-11"	18'-4"	-	-	-	19'-9"
	14"	30'-9"	27'-7"	23'-11"	19'-1"	-	-	25'-2"	21'-8"
	16"	34'-1"	29'-8"	24'-9"	19'-9"	-	29'-9"	27'-1"	23'-0"

#### Design Assumptions:

1. The spans listed are the clear distance between supports. Continuous spans are based on the longest span. The shortest span shall not be less than 50% of the longest span.
2. The spans are based on uniform floor loads as listed at the top of this page.
3. These tables reflect the additional stiffness provided by 48/24 APA RATED SHEATHING or 24 oc APA RATED STURD-I-FLOOR, or equal, glued and nailed to the top flange.
4. Live Load deflection is limited to L/480 or L/360 for simple spans as listed, and L/480 only for continuous spans.
5. Total Load deflection is limited to L/240.
6. The spans are based on an end bearing length of at least 1-3/4" and an interior bearing length of at least 3-1/2", and are limited to the bearing capacity for an SPF wall plate (Fc1 = 425 psi).

#### Additional Notes:

1. Web stiffeners are not required for the Simple Span tables. Web stiffeners are not required at the end bearings for the Continuous Span tables. Web stiffeners at interior supports are only required where listed in the "With Web Stiffeners" section of each table. A "-" indicates no increase in span with web stiffeners.
2. Web fillers are required for I-Joists seated in hangers that do not laterally support the top flange.
3. L/360 represents the maximum deflection allowed per code and may not provide suitable floor performance. L/480 or better is recommended for most applications.
4. These spans are not evaluated for vibration.
5. Though not required for the spans above, bridging, blocking, bottom-flange bracing or a direct-applied gypsum ceiling can improve the feel of a floor.
6. For conditions not shown, use the Uniform Floor Load (PLF) tables, the Exacte by PWT software, or contact your PWT distributor for assistance.

# Roof Span Tables

## Table Usage:

1. Select the appropriate set of tables based on roof pitch.
2. Select the section of that table that corresponds to the design roof live load (snow or non-snow).
3. Find a span that meets or exceeds the design span for the appropriate roof dead load (15 psf or 20 psf).
4. Read the corresponding series, depth and spacing.

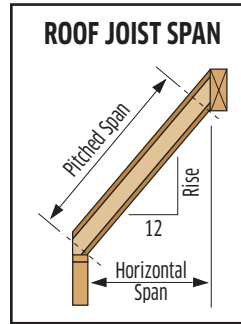

## ACTUAL DEFLECTION BASED ON SPAN AND LIMIT

Span (ft)	L/360	L/240	L/180
10'	5/16"	1/2"	11/16"
12'	3/8"	5/8"	13/16"
14'	7/16"	11/16"	15/16"
16'	9/16"	13/16"	1-1/16"
18'	5/8"	7/8"	1-3/16"
20'	11/16"	1"	1-5/16"
22'	3/4"	1-1/8"	1-7/16"
24'	13/16"	1-13/16"	1-5/8"
26'	7/8"	1-5/16"	1-3/4"
28'	15/16"	1-3/8"	1-7/8"
30'	1"	1-1/2"	2"

\*Deflections rounded to the nearest 1/16"

## Low Pitch (6:12 or less) for 20 PSF 115% Snow or 125% Non-Snow Loads

Series	Depth	16" oc		19.2" oc		24" oc	
		15 psf	20 psf	15 psf	20 psf	15 psf	20 psf
PWI 18S, LPI 18	9-1/2"	19'-4"	18'-5"	18'-2"	17'-3"	16'-9"	15'-9"
	11-7/8"	23'-4"	22'-2"	21'-9"	20'-3"	19'-5"	18'-1"
PWI 20S, LPI 20Plus	9-1/2"	21'-1"	20'-1"	19'-10"	18'-10"	18'-4"	17'-3"
	11-7/8"	25'-4"	24'-1"	23'-9"	22'-4"	21'-5"	19'-11"
	14"	28'-6"	26'-6"	26'-0"	24'-2"	23'-3"	21'-7"
PWI 32S, LPI 32Plus	9-1/2"	22'-10"	21'-9"	21'-5"	20'-5"	19'-9"	18'-10"
	11-7/8"	27'-2"	25'-10"	25'-6"	24'-3"	23'-7"	22'-4"
	14"	30'-10"	29'-4"	28'-11"	27'-5"	26'-4"	24'-6"
PWI 42S, LPI 42Plus	11-7/8"	34'-1"	32'-5"	31'-9"	29'-7"	28'-4"	26'-5"
	14"	30'-4"	28'-11"	28'-6"	27'-2"	26'-5"	25'-1"
	16"	34'-6"	32'-11"	32'-5"	30'-10"	30'-0"	28'-7"
	16"	38'-3"	36'-6"	36'-0"	34'-3"	33'-4"	31'-8"

## High Pitch (6:12 to 12:12) for 20 PSF 115% Snow or 125% Non-Snow Loads

Series	Depth	16" oc		19.2" oc		24" oc	
		15 psf	20 psf	15 psf	20 psf	15 psf	20 psf
PWI 18S, LPI 18	9-1/2"	17'-3"	16'-4"	16'-2"	15'-4"	15'-0"	14'-2"
	11-7/8"	20'-9"	19'-8"	19'-6"	18'-6"	18'-1"	16'-11"
PWI 20S, LPI 20Plus	9-1/2"	18'-10"	17'-10"	17'-8"	16'-9"	16'-4"	15'-6"
	11-7/8"	22'-7"	21'-5"	21'-2"	20'-1"	19'-8"	18'-7"
	14"	25'-10"	24'-5"	24'-3"	22'-8"	21'-11"	20'-3"
PWI 32S, LPI 32Plus	9-1/2"	28'-9"	26'-7"	26'-4"	24'-3"	23'-6"	21'-8"
	11-7/8"	20'-5"	19'-4"	19'-2"	18'-2"	17'-9"	16'-9"
	14"	24'-4"	23'-0"	22'-10"	21'-7"	21'-1"	19'-11"
PWI 42S, LPI 42Plus	11-7/8"	27'-7"	26'-1"	25'-10"	24'-6"	23'-11"	22'-7"
	14"	30'-5"	28'-10"	28'-7"	27'-0"	26'-5"	23'-5"
	16"	27'-1"	25'-8"	25'-5"	24'-1"	23'-7"	22'-4"
	14"	30'-9"	29'-2"	28'-11"	27'-5"	26'-10"	25'-4"
	16"	34'-2"	32'-4"	32'-1"	30'-5"	29'-9"	28'-2"

### Design Assumptions:

1. The spans listed are the horizontal clear distance between supports and are valid for simple or continuous span applications. Continuous spans are based on the longest span. The shortest span shall not be less than 50% of the longest span.
2. The spans are based on uniform gravity loads only as listed for each table, including the effects of a 300 lb concentrated load. These spans have not been evaluated for wind.
3. These tables do not reflect any additional stiffness provided by the roof sheathing.
4. Live load deflection is limited to L/240.
5. Total load deflection is limited to L/180.
6. The spans are based on an end bearing length of at least 1-3/4" and an interior bearing length of at least 3-1/2", and are limited to the bearing capacity for an SPF wall plate (Fc1 = 425 psi).

### Additional Notes:

1. Web stiffeners are not required for the Roof Span tables except when using a "bird's mouth" detail for the low-end bearing. Web fillers are required for I-Joists seated in hangers that do not laterally support the top flange or for hangers that require nailing into the web.
2. L/240 represents the maximum deflection allowed per code for roof joists supporting non-plaster ceilings. Verify deflection limits with local code requirements.
3. Roof joists shall have a minimum pitch of 1/4" per foot (1/4:12) for positive drainage.
4. Roof applications in high wind areas require special analysis which may reduce spans and may require bracing of the bottom flange and special connectors to resist uplift.
5. For conditions not shown, use the Uniform Roof Load (PLF) tables, the Exacte by PWT software, or contact your PWT distributor for assistance.



# Roof Span Tables

## Table Usage:

1. Select the appropriate set of tables based on roof pitch.
2. Select the section of that table that corresponds to the design roof live load (snow or non-snow).
3. Find a span that meets or exceeds the design span for the appropriate roof dead load (15 psf or 20 psf).
4. Read the corresponding series, depth and spacing.

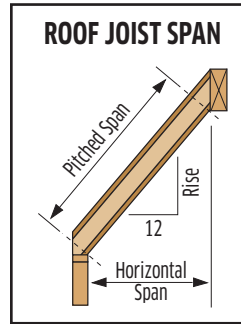

## ACTUAL DEFLECTION BASED ON SPAN AND LIMIT

Span (ft)	L/360	L/240	L/180
10'	5/16"	1/2"	11/16"
12'	3/8"	5/8"	13/16"
14'	7/16"	11/16"	15/16"
16'	9/16"	13/16"	1-1/16"
18'	5/8"	7/8"	1-3/16"
20'	11/16"	1"	1-5/16"
22'	3/4"	1-1/8"	1-7/16"
24'	13/16"	1-13/16"	1-5/8"
26'	7/8"	1-5/16"	1-3/4"
28'	15/16"	1-3/8"	1-7/8"
30'	1"	1-1/2"	2"

\*Deflections rounded to the nearest 1/16"

## Low Pitch (6:12 or less) for 25 115% Snow Load

Series	Depth	16" oc		19.2" oc		24" oc	
		15 psf	20 psf	15 psf	20 psf	15 psf	20 psf
PWI 18S, LPI 18	9-1/2"	18'-6"	17'-8"	17'-4"	16'-7"	15'-11"	14'-11"
	11-7/8"	22'-4"	21'-0"	20'-5"	19'-2"	18'-3"	17'-1"
PWI 20S, LPI 20Plus	9-1/2"	20'-2"	19'-4"	18'-11"	18'-2"	17'-4"	16'-3"
	11-7/8"	24'-3"	23'-2"	22'-6"	21'-1"	20'-1"	18'-10"
	14"	26'-9"	25'-1"	24'-4"	22'-10"	21'-9"	20'-5"
PWI 32S, LPI 32Plus	16"	28'-8"	26'-10"	26'-1"	24'-6"	23'-4"	21'-11"
	9-1/2"	21'-10"	20'-11"	20'-6"	19'-7"	18'-11"	18'-1"
	11-7/8"	26'-0"	24'-10"	24'-4"	23'-4"	22'-6"	21'-1"
PWI 42S, LPI 42Plus	14"	29'-6"	28'-2"	27'-8"	25'-11"	24'-8"	23'-2"
	16"	32'-7"	30'-8"	29'-9"	27'-11"	26'-7"	23'-11"
	11-7/8"	29'-1"	27'-10"	27'-3"	26'-1"	25'-3"	24'-2"
PWI 42S, LPI 42Plus	14"	33'-0"	31'-8"	31'-0"	29'-8"	28'-8"	27'-6"
	16"	36'-8"	35'-1"	34'-5"	32'-11"	31'-10"	30'-6"

## High Pitch (6:12 to 12:12) for 25 115% Snow Load

Series	Depth	16" oc		19.2" oc		24" oc	
		15 psf	20 psf	15 psf	20 psf	15 psf	20 psf
PWI 18S, LPI 18	9-1/2"	16'-7"	15'-9"	15'-7"	14'-10"	14'-5"	13'-8"
	11-7/8"	20'-0"	19'-0"	18'-9"	17'-10"	17'-4"	16'-1"
PWI 20S, LPI 20Plus	9-1/2"	18'-1"	17'-3"	17'-0"	16'-2"	15'-9"	15'-0"
	11-7/8"	21'-8"	20'-8"	20'-5"	19'-5"	18'-10"	17'-9"
	14"	24'-10"	23'-7"	23'-2"	21'-6"	20'-8"	19'-3"
PWI 32S, LPI 32Plus	16"	27'-3"	25'-4"	24'-10"	23'-1"	22'-2"	20'-8"
	9-1/2"	19'-8"	18'-8"	18'-5"	17'-6"	17'-0"	16'-2"
	11-7/8"	23'-4"	22'-3"	21'-11"	20'-10"	20'-3"	19'-3"
PWI 42S, LPI 42Plus	14"	26'-6"	25'-2"	24'-10"	23'-8"	23'-0"	21'-1"
	16"	29'-3"	27'-10"	27'-5"	26'-1"	24'-6"	21'-2"
	11-7/8"	26'-0"	24'-9"	24'-5"	23'-3"	22'-8"	21'-7"
PWI 42S, LPI 42Plus	14"	29'-7"	28'-2"	27'-10"	26'-6"	25'-9"	24'-6"
	16"	32'-10"	31'-3"	30'-10"	29'-5"	28'-7"	27'-2"

### Design Assumptions:

1. The spans listed are the horizontal clear distance between supports and are valid for simple or continuous span applications. Continuous spans are based on the longest span. The shortest span shall not be less than 50% of the longest span.
2. The spans are based on uniform gravity loads only as listed for each table, including the effects of a 300 lb concentrated load. These spans have not been evaluated for wind.
3. These tables do not reflect any additional stiffness provided by the roof sheathing.
4. Live load deflection is limited to L/240.
5. Total load deflection is limited to L/180.
6. The spans are based on an end bearing length of at least 1-3/4" and an interior bearing length of at least 3-1/2", and are limited to the bearing capacity for an SPF wall plate (F<sub>c1</sub> = 425 psi).

### Additional Notes:

1. Web stiffeners are not required for the Roof Span tables except when using a "bird's mouth" detail for the low-end bearing. Web fillers are required for I-Joists seated in hangers that do not laterally support the top flange or for hangers that require nailing into the web.
2. L/240 represents the maximum deflection allowed per code for roof joists supporting non-plaster ceilings. Verify deflection limits with local code requirements.
3. Roof joists shall have a minimum pitch of 1/4" per foot (1/4:12) for positive drainage.
4. Roof applications in high wind areas require special analysis which may reduce spans and may require bracing of the bottom flange and special connectors to resist uplift.
5. For conditions not shown, use the Uniform Roof Load (PLF) tables, the Exacte by PWT software, or contact your PWT distributor for assistance.

# Roof Span Tables

## Table Usage:

1. Select the appropriate set of tables based on roof pitch.
2. Select the section of that table that corresponds to the design roof live load (snow or non-snow).
3. Find a span that meets or exceeds the design span for the appropriate roof dead load (15 psf or 20 psf).
4. Read the corresponding series, depth and spacing.

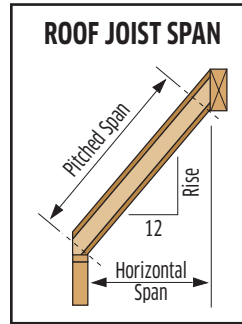

## ACTUAL DEFLECTION BASED ON SPAN AND LIMIT

Span (ft)	L/360	L/240	L/180
10'	5/16"	1/2"	11/16"
12'	3/8"	5/8"	13/16"
14'	7/16"	11/16"	15/16"
16'	9/16"	13/16"	1-1/16"
18'	5/8"	7/8"	1-3/16"
20'	11/16"	1"	1-5/16"
22'	3/4"	1-1/8"	1-7/16"
24'	13/16"	1-13/16"	1-5/8"
26'	7/8"	1-5/16"	1-3/4"
28'	15/16"	1-3/8"	1-7/8"
30'	1"	1-1/2"	2"

\*Deflections rounded to the nearest 1/16"

## Low Pitch (6:12 or less) for 30 115% Snow Load

Series	Depth	16" oc		19.2" oc		24" oc	
		15 psf	20 psf	15 psf	20 psf	15 psf	20 psf
PWI 18S, LPI 18	9-1/2"	17'-9"	17'-1"	16'-8"	15'-10"	15'-0"	14'-2"
	11-7/8"	21'-2"	20'-0"	19'-3"	18'-2"	17'-3"	16'-3"
PWI 20S, LPI 20Plus	9-1/2"	19'-5"	18'-8"	18'-3"	17'-4"	16'-4"	15'-6"
	11-7/8"	23'-3"	22'-0"	21'-3"	20'-1"	19'-0"	17'-11"
	14"	25'-3"	23'-10"	23'-0"	21'-9"	20'-7"	19'-5"
	16"	27'-1"	25'-7"	24'-8"	23'-4"	22'-0"	20'-10"
PWI 32S, LPI 32Plus	9-1/2"	21'-0"	20'-2"	19'-8"	18'-11"	18'-2"	17'-5"
	11-7/8"	25'-0"	24'-0"	23'-5"	22'-5"	21'-3"	20'-1"
	14"	28'-4"	27'-0"	26'-1"	24'-8"	23'-4"	21'-6"
	16"	30'-10"	29'-1"	28'-1"	26'-7"	24'-2"	21'-7"
PWI 42S, LPI 42Plus	11-7/8"	27'-11"	26'-10"	26'-3"	25'-3"	24'-3"	23'-4"
	14"	31'-9"	30'-7"	29'-10"	28'-8"	27'-7"	26'-6"
	16"	35'-3"	33'-11"	33'-1"	31'-10"	30'-8"	29'-0"

## High Pitch (6:12 to 12:12) for 30 115% Snow Load

Series	Depth	16" oc		19.2" oc		24" oc	
		15 psf	20 psf	15 psf	20 psf	15 psf	20 psf
PWI 18S, LPI 18	9-1/2"	16'-0"	15'-3"	15'-0"	14'-4"	13'-11"	13'-3"
	11-7/8"	19'-3"	18'-5"	18'-1"	17'-3"	16'-5"	15'-5"
PWI 20S, LPI 20Plus	9-1/2"	17'-5"	16'-8"	16'-5"	15'-8"	15'-2"	14'-6"
	11-7/8"	20'-11"	20'-0"	19'-8"	18'-10"	18'-1"	17'-0"
	14"	24'-0"	22'-7"	22'-0"	20'-7"	19'-8"	18'-5"
	16"	25'-10"	24'-2"	23'-7"	22'-1"	21'-1"	19'-4"
PWI 32S, LPI 32Plus	9-1/2"	18'-11"	18'-1"	17'-9"	17'-0"	16'-5"	15'-8"
	11-7/8"	22'-6"	21'-6"	21'-2"	20'-2"	19'-6"	18'-8"
	14"	25'-7"	24'-5"	24'-0"	22'-11"	22'-0"	19'-3"
	16"	28'-3"	27'-0"	26'-6"	24'-3"	22'-1"	19'-4"
PWI 42S, LPI 42Plus	11-7/8"	25'-2"	24'-0"	23'-7"	22'-7"	21'-10"	20'-11"
	14"	28'-7"	27'-4"	26'-10"	25'-8"	24'-10"	23'-9"
	16"	31'-9"	30'-4"	29'-9"	28'-6"	27'-7"	26'-4"

### Design Assumptions:

1. The spans listed are the horizontal clear distance between supports and are valid for simple or continuous span applications. Continuous spans are based on the longest span. The shortest span shall not be less than 50% of the longest span.
2. The spans are based on uniform gravity loads only as listed for each table, including the effects of a 300 lb concentrated load. These spans have not been evaluated for wind.
3. These tables do not reflect any additional stiffness provided by the roof sheathing.
4. Live load deflection is limited to L/240.
5. Total load deflection is limited to L/180.
6. The spans are based on an end bearing length of at least 1-3/4" and an interior bearing length of at least 3-1/2", and are limited to the bearing capacity for an SPF wall plate (F<sub>c1</sub> = 425 psi).

### Additional Notes:

1. Web stiffeners are not required for the Roof Span tables except when using a "bird's mouth" detail for the low-end bearing. Web fillers are required for I-Joists seated in hangers that do not laterally support the top flange or for hangers that require nailing into the web.
2. L/240 represents the maximum deflection allowed per code for roof joists supporting non-plaster ceilings. Verify deflection limits with local code requirements.
3. Roof joists shall have a minimum pitch of 1/4" per foot (1/4:12) for positive drainage.
4. Roof applications in high wind areas require special analysis which may reduce spans and may require bracing of the bottom flange and special connectors to resist uplift.
5. For conditions not shown, use the Uniform Roof Load (PLF) tables, the Exacte by PWT software, or contact your PWT distributor for assistance.

# Roof Span Tables

## Table Usage:

1. Select the appropriate set of tables based on roof pitch.
2. Select the section of that table that corresponds to the design roof live load (snow or non-snow).
3. Find a span that meets or exceeds the design span for the appropriate roof dead load (15 psf or 20 psf).
4. Read the corresponding series, depth and spacing.

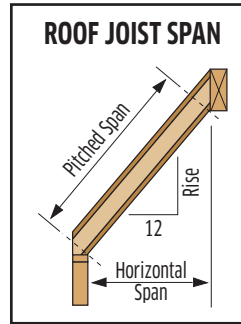

## ACTUAL DEFLECTION BASED ON SPAN AND LIMIT

Span (ft)	L/360	L/240	L/180
10'	5/16"	1/2"	11/16"
12'	3/8"	5/8"	13/16"
14'	7/16"	11/16"	15/16"
16'	9/16"	13/16"	1-1/16"
18'	5/8"	7/8"	1-3/16"
20'	11/16"	1"	1-5/16"
22'	3/4"	1-1/8"	1-7/16"
24'	13/16"	1-13/16"	1-5/8"
26'	7/8"	1-5/16"	1-3/4"
28'	15/16"	1-3/8"	1-7/8"
30'	1"	1-1/2"	2"

\*Deflections rounded to the nearest 1/16"

## Low Pitch (6:12 or less) for 40 115% Snow Load

Series	Depth	16" oc		19.2" oc		24" oc	
		15 psf	20 psf	15 psf	20 psf	15 psf	20 psf
PWI 18S, LPI 18	9-1/2"	16'-7"	15'-11"	15'-3"	14'-6"	13'-7"	12'-11"
	11-7/8"	19'-2"	18'-3"	17'-6"	16'-8"	15'-7"	14'-10"
PWI 20S, LPI 20Plus	9-1/2"	18'-2"	17'-5"	16'-7"	15'-10"	14'-10"	14'-2"
	11-7/8"	21'-1"	20'-2"	19'-3"	18'-4"	17'-2"	16'-5"
	14"	22'-11"	21'-10"	20'-10"	19'-11"	18'-8"	17'-9"
	16"	24'-6"	23'-5"	22'-4"	21'-4"	19'-10"	18'-1"
PWI 32S, LPI 32Plus	9-1/2"	19'-7"	18'-11"	18'-4"	17'-9"	16'-11"	16'-1"
	11-7/8"	23'-4"	22'-6"	21'-7"	20'-7"	19'-3"	17'-7"
	14"	25'-11"	24'-9"	23'-8"	22'-7"	19'-9"	18'-0"
	16"	27'-11"	26'-8"	24'-11"	22'-8"	19'-10"	18'-1"
PWI 42S, LPI 42Plus	11-7/8"	26'-1"	25'-3"	24'-6"	23'-9"	22'-8"	21'-11"
	14"	29'-9"	28'-9"	27'-11"	27'-0"	25'-10"	23'-10"
	16"	33'-0"	31'-11"	30'-11"	29'-8"	26'-11"	24'-8"

## High Pitch (6:12 to 12:12) for 40 115% Snow Load

Series	Depth	16" oc		19.2" oc		24" oc	
		15 psf	20 psf	15 psf	20 psf	15 psf	20 psf
PWI 18S, LPI 18	9-1/2"	15'-0"	14'-6"	14'-1"	13'-7"	13'-1"	12'-4"
	11-7/8"	18'-2"	17'-5"	16'-10"	15'-11"	15'-0"	14'-2"
PWI 20S, LPI 20Plus	9-1/2"	16'-5"	15'-10"	15'-5"	14'-10"	14'-3"	13'-6"
	11-7/8"	19'-8"	19'-0"	18'-6"	17'-6"	16'-7"	15'-8"
	14"	22'-0"	20'-10"	20'-1"	19'-0"	17'-11"	16'-5"
	16"	23'-7"	22'-4"	21'-6"	20'-4"	18'-5"	16'-5"
PWI 32S, LPI 32Plus	9-1/2"	17'-9"	17'-1"	16'-8"	16'-0"	15'-5"	14'-10"
	11-7/8"	21'-2"	20'-4"	19'-10"	19'-1"	18'-3"	16'-4"
	14"	24'-0"	23'-1"	22'-6"	20'-7"	18'-4"	16'-5"
	16"	26'-6"	24'-10"	23'-1"	20'-8"	18'-5"	16'-5"
PWI 42S, LPI 42Plus	11-7/8"	23'-8"	22'-9"	22'-2"	21'-4"	20'-6"	19'-9"
	14"	26'-11"	25'-11"	25'-3"	24'-4"	23'-4"	22'-1"
	16"	29'-10"	28'-9"	28'-0"	27'-0"	25'-6"	22'-10"

### Design Assumptions:

1. The spans listed are the horizontal clear distance between supports and are valid for simple or continuous span applications. Continuous spans are based on the longest span. The shortest span shall not be less than 50% of the longest span.
2. The spans are based on uniform gravity loads only as listed for each table, including the effects of a 300 lb concentrated load. These spans have not been evaluated for wind.
3. These tables do not reflect any additional stiffness provided by the roof sheathing.
4. Live load deflection is limited to L/240.
5. Total load deflection is limited to L/180.
6. The spans are based on an end bearing length of at least 1-3/4" and an interior bearing length of at least 3-1/2", and are limited to the bearing capacity for an SPF wall plate (F<sub>c1</sub> = 425 psi).

### Additional Notes:

1. Web stiffeners are not required for the Roof Span tables except when using a "bird's mouth" detail for the low-end bearing. Web fillers are required for I-Joists seated in hangers that do not laterally support the top flange or for hangers that require nailing into the web.
2. L/240 represents the maximum deflection allowed per code for roof joists supporting non-plaster ceilings. Verify deflection limits with local code requirements.
3. Roof joists shall have a minimum pitch of 1/4" per foot (1/4:12) for positive drainage.
4. Roof applications in high wind areas require special analysis which may reduce spans and may require bracing of the bottom flange and special connectors to resist uplift.
5. For conditions not shown, use the Uniform Roof Load (PLF) tables, the Exacte by PWT software, or contact your PWT distributor for assistance.

# Cantilever Details

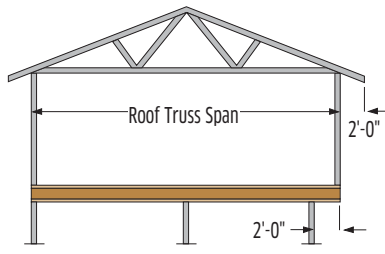

**C1 NO REINFORCEMENT REQUIRED**

Min. APA Rated 23/32" OSB (or equal) closure, or as required by code

PWI Blocking\*

As Designed

\*Rim Board or PWT LVL may be substituted for the PWI Blocking

**C1W WEB STIFFENER REQUIRED**

Min. APA Rated 23/32" OSB (or equal) closure, or as required by code

Web Stiffener

PWI Blocking\*

As Designed

\*Rim Board or PWT LVL may be substituted for the PWI Blocking

**C2 23/32" OSB (OR EQUAL) REINFORCEMENT ONE SIDE ONLY**

Min. APA Rated 23/32" OSB (or equal) closure, or as required by code

Min. APA Rated 23/32" OSB (or equal) reinforcement one side, 4'-0" long minimum

PWI Blocking\*

2'-0" max. 2'-0" min.

Attach reinforcement to top and bottom flanges with 8d nails at 6" oc

\*Rim Board or PWT LVL may be substituted for the PWI Blocking

**C3 23/32" OSB (OR EQUAL) REINFORCEMENT BOTH SIDES**

Min. APA Rated 23/32" OSB (or equal) closure, or as required by code

Min. APA Rated 23/32" OSB (or equal) reinforcement both sides, 4'-0" long minimum

PWI Blocking\*

2'-0" max. 2'-0" min.

Attach reinforcement to top and bottom flanges with 8d nails at 6" oc both sides with nails staggered to avoid splitting

\*Rim Board or PWT LVL may be substituted for the PWI Blocking

**C7 BRICK LEDGE CANTILEVER WEB FILLER REINFORCING**

Web fillers both sides (refer to table below for size)

12" min.

Leave 1/8" gap

Nail web filler with two rows of (3) 10d or (3) 12d box or equivalent gun nails, clinched

Use construction adhesive between surfaces

6" max.

Blocking panels are required at the bearing, but are not shown for clarity

Series	Minimum Web Filler	Reaction Capacity (lbs)
PWI 18S, LPI 18	23/32" APA Rated OSB (or equal)	2300
PWI 20S, LPI 20Plus, PWI 32S, LPI 32Plus	23/32" APA Rated OSB (or equal)	2600
PWI 42S, LPI 42Plus	1-1/8" APA Rated OSB (or equal)	4000

**C8 BRICK LEDGE CANTILEVER FULL-DEPTH REINFORCING ONE SIDE**

23/32" APA Rated OSB or 1" (min.) Rim Board reinforcing.

14" and deeper I-Joists also require web fillers both sides (see C7).

Nail or screw reinforcing with (3) 6d or 8d box nails or #6 x 1-1/2" wood screws into both flanges\*

Construction adhesive is recommended between surfaces

Blocking panels are required at the bearing, but are not shown for clarity

Reinforcing shall be same depth as I-Joist

2" min. from I-Joist end

6" max.

12" min. reinforcing - 12" min.

18" min. reinforcing - 18" min.

\*Note: Pilot holes required when using screws

Series	Reaction Capacity (lbs)	
	23/32" APA Rated OSB (or equal)	1" Min. Rim Board
PWI 18S, LPI 18	3100	3400
PWI 20S, LPI 20Plus, PWI 32S, LPI 32Plus	3500	3800
PWI 42S, LPI 42Plus	4800	5200

# Brick-Ledge Cantilevers

## TOTAL JOIST REACTION CALCULATION

PWT™ I-Joists can cantilever up to 6" to support a load-bearing wall over a brick finish. Depending on the Total Joist Reaction (TJR), the joists may require reinforcement. If the TJR is less than the End Reaction Capacity without Stiffeners (page 4), then no reinforcement is required. If the TJR is greater than the End Reaction Capacity without Stiffeners, but less than the End Reaction Capacity With Stiffeners, then web stiffeners shall be installed at the bearing. Otherwise, one of the reinforcing details from below shall be used.

### Total Joist Reaction, TJR = FLR + WLR + RLR

Where: **FLR** = Floor Load Reaction  
**WLR** = Wall Load Reaction  
**RLR** = Roof Load Reaction, including any other floor, ceiling or attic loads imposed on wall

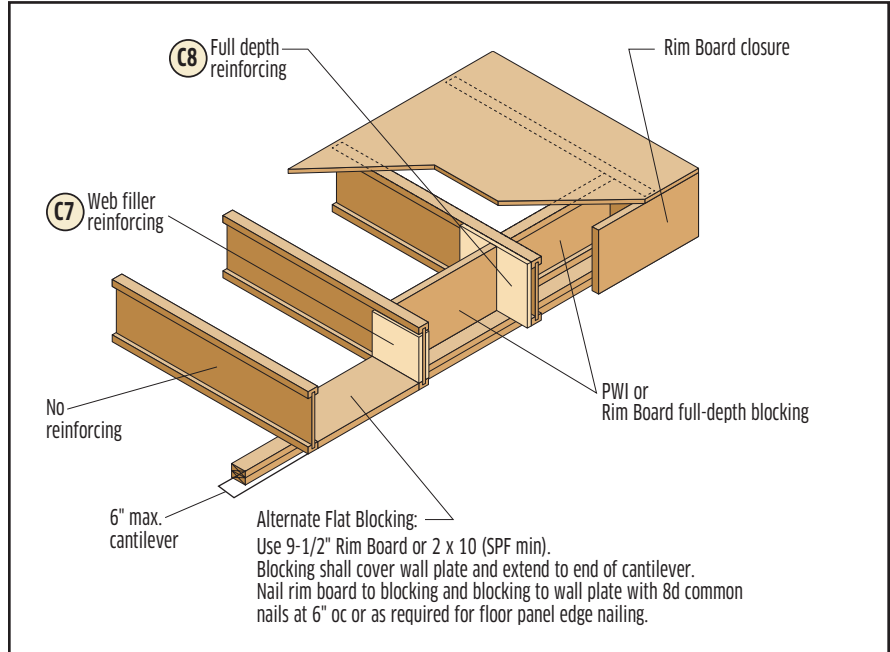

## EXAMPLE

I-Joist: 9-1/2" PWI 20S, Wall under Cantilever: 3-1/2" wide

**Design Loads:** Floor: 40/10 psf    **Floor System:** Joist Span = 16'  
 Roof: 20/10 psf                      Joist Cantilever = 5"  
 Wall: 80 plf                              Joist Spacing = 16" oc  
**Roof System:** Roof Span = 22'  
 Roof Overhang = 1'

$$\begin{aligned} \text{FLR} &= (\text{Joist Span} / 2 + \text{Joist Cantilever} / 12) * (\text{Design Floor Load}) * (\text{Joist Spacing} / 12) \\ &= (16' / 2 + 5" / 12) * (40 \text{ psf} + 10 \text{ psf}) * (16" / 12) \\ &= 561 \text{ lbs.} \end{aligned}$$

$$\begin{aligned} \text{WLR} &= (\text{Design Wall Load}) * (\text{Joist Spacing} / 12) \\ &= (80 \text{ plf}) * (16" / 12) \\ &= 107 \text{ lbs.} \end{aligned}$$

$$\begin{aligned} \text{RLR} &= (\text{Roof Span} / 2 + \text{Roof Overhang}) * (\text{Design Roof Load}) * (\text{Joist Spacing} / 12) \\ &= (22' / 2 + 1') * (20 \text{ psf} + 10 \text{ psf}) * (16" / 12) \\ &= 480 \text{ lbs.} \end{aligned}$$

$$\begin{aligned} \text{TJR} &= 561 + 107 + 480 \\ &= 1148 \text{ lbs.} \end{aligned}$$

## ALLOWABLE END REACTION CAPACITY

9-1/2" PWI 20S on a 3-1/2" wall	@ 1-1/2" Bearing	@ 4" Bearing	@ 3-1/2" Bearing
Without Web Stiffeners	970	1110	1082
With Web Stiffeners	1140	1260	1236
With Web Filler Reinforcing	-	-	2600
With 23/32" APA Rated Sheathing Full-Depth Reinforcing (One Side)	-	-	3500
With 1" Rim Board Full-Depth Reinforcing (One Side)	-	-	3800

Since the Total Joist Reaction, 1148 lbs., is greater than the End Reaction Capacity without Stiffeners, 1082 lbs., but less than End Reaction Capacity with Stiffeners, 1236 lbs., this joist only requires the installation of web stiffeners at the bearing.

# Web Hole Specifications

## Circular Holes

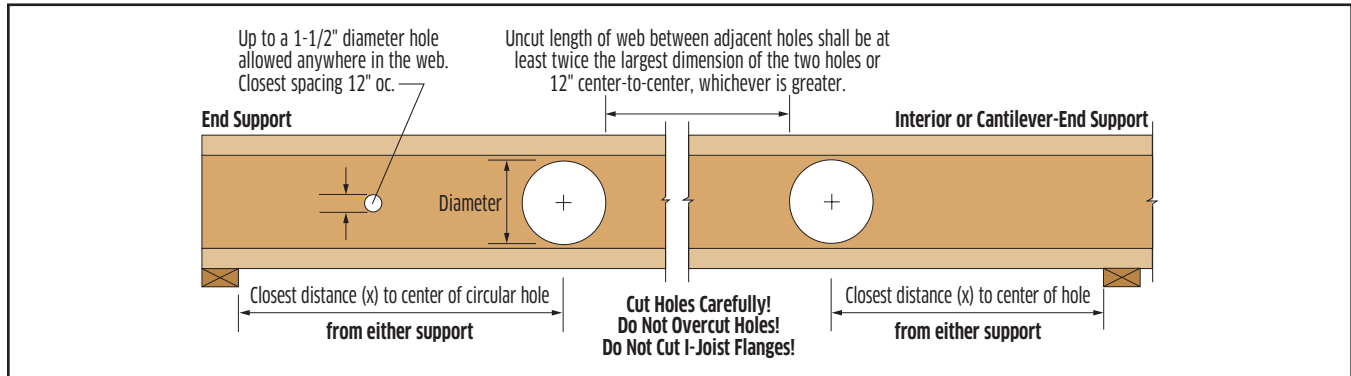

### Table Usage:

1. Select the required series and depth.
2. Determine the support condition for the nearest bearing: end support or interior support (including cantilever-end supports).
3. Select the row corresponding to the required Clear Span. For spans between those listed, use the next largest value.
4. Select the column corresponding to the required hole diameter. For diameters between those listed, use the next largest value.
5. The intersection of the Clear Span row and Hole Diameter column gives the minimum distance from the inside face of bearing to the center of a circular hole.
6. Double check the distance to the other support, using the appropriate support condition.

Series	Depth	Clear Span (ft)	Distance from End Support					Distance from Interior or Cantilever-End Support							
			Hole Diameter					Hole Diameter							
			2"	4"	6"	8"	10"	12"	2"	4"	6"	8"	10"	12"	
PWI 18S, LPI 18	9-1/2"	6	1'-0"	1'-0"	1'-0"	-	-	-	1'-0"	1'-0"	1'-0"	-	-	-	
		10	1'-0"	1'-0"	2'-1"	-	-	-	1'-0"	1'-3"	3'-1"	-	-	-	
		14	1'-0"	2'-2"	4'-6"	-	-	-	1'-11"	3'-9"	5'-7"	-	-	-	
	11-7/8"	18	2'-4"	4'-7"	7'-2"	-	-	-	4'-5"	6'-3"	8'-4"	-	-	-	
		10	1'-0"	1'-0"	1'-0"	1'-10"	-	-	1'-0"	1'-0"	1'-3"	3'-0"	-	-	
		14	1'-0"	1'-0"	2'-1"	4'-4"	-	-	1'-0"	2'-0"	3'-9"	5'-6"	-	-	
PWI 20S, LPI 20Plus & PWI 32S, LPI 32Plus	9-1/2"	18	1'-0"	2'-5"	4'-6"	6'-11"	-	-	2'-9"	4'-6"	6'-3"	8'-1"	-	-	
		22	2'-8"	4'-9"	7'-0"	9'-8"	-	-	5'-3"	7'-0"	8'-9"	11'-0"	-	-	
		6	1'-0"	1'-0"	1'-0"	-	-	-	1'-0"	1'-0"	1'-0"	-	-	-	
	11-7/8"	10	1'-0"	1'-0"	1'-0"	1'-0"	-	-	1'-0"	1'-0"	1'-0"	-	-	-	
		14	1'-0"	1'-0"	1'-0"	1'-9"	-	-	1'-0"	1'-0"	2'-1"	3'-5"	-	-	
		18	1'-0"	1'-0"	2'-6"	4'-1"	-	-	1'-10"	3'-3"	4'-7"	5'-11"	-	-	
	14"	22	1'-8"	3'-2"	4'-10"	6'-7"	-	-	4'-4"	5'-9"	7'-1"	8'-5"	-	-	
		14	1'-0"	1'-0"	1'-0"	1'-0"	2'-2"	-	-	1'-0"	1'-0"	1'-5"	2'-7"	3'-9"	-
		18	1'-0"	1'-0"	1'-9"	3'-1"	4'-6"	-	-	1'-8"	2'-10"	3'-11"	5'-1"	6'-3"	-
	16"	22	1'-5"	2'-9"	4'-1"	5'-6"	7'-0"	-	-	4'-2"	5'-4"	6'-5"	7'-7"	8'-9"	-
		26	3'-8"	5'-0"	6'-5"	8'-0"	9'-8"	-	-	6'-8"	7'-10"	8'-11"	10'-1"	11'-4"	-
		18	1'-0"	1'-0"	1'-4"	2'-5"	3'-7"	4'-11"	-	1'-6"	2'-6"	3'-6"	4'-6"	5'-6"	6'-6"
PWI 42S, LPI 42Plus	11-7/8"	22	1'-4"	2'-5"	3'-6"	4'-9"	6'-1"	7'-5"	4'-0"	5'-0"	6'-0"	7'-0"	8'-0"	9'-0"	
		26	3'-6"	4'-8"	5'-11"	7'-2"	8'-7"	10'-1"	6'-6"	7'-6"	8'-6"	9'-6"	10'-6"	11'-9"	
		30	5'-9"	7'-0"	8'-4"	9'-9"	11'-3"	12'-10"	9'-0"	10'-0"	11'-0"	12'-0"	13'-2"	14'-8"	
	14"	10	1'-0"	1'-0"	1'-0"	1'-0"	-	-	1'-0"	1'-0"	1'-0"	1'-0"	-	-	
		14	1'-0"	1'-0"	1'-0"	1'-9"	-	-	1'-0"	1'-0"	2'-1"	3'-5"	-	-	
		18	1'-0"	1'-0"	2'-6"	4'-1"	-	-	1'-10"	3'-3"	4'-7"	5'-11"	-	-	
16"	22	1'-8"	3'-2"	4'-10"	6'-7"	-	-	4'-4"	5'-9"	7'-1"	8'-5"	-	-		
	14	1'-0"	1'-0"	1'-0"	1'-0"	2'-2"	-	-	1'-0"	1'-0"	1'-5"	2'-7"	3'-9"	-	
	18	1'-0"	1'-0"	1'-9"	3'-1"	4'-6"	-	-	1'-8"	2'-10"	3'-11"	5'-1"	6'-3"	-	
16"	22	1'-5"	2'-9"	4'-1"	5'-6"	7'-0"	-	-	4'-2"	5'-4"	6'-5"	7'-7"	8'-9"	-	
	26	3'-8"	5'-0"	6'-5"	8'-0"	9'-8"	-	-	6'-8"	7'-10"	8'-11"	10'-1"	11'-4"	-	
	18	1'-0"	1'-0"	1'-4"	2'-5"	3'-7"	4'-11"	-	1'-6"	2'-6"	3'-6"	4'-6"	5'-6"	6'-6"	
16"	22	1'-4"	2'-5"	3'-6"	4'-9"	6'-1"	7'-5"	4'-0"	5'-0"	6'-0"	7'-0"	8'-0"	9'-0"		
	26	3'-6"	4'-8"	5'-11"	7'-2"	8'-7"	10'-1"	6'-6"	7'-6"	8'-6"	9'-6"	10'-6"	11'-9"		
	30	5'-9"	7'-0"	8'-4"	9'-9"	11'-3"	12'-10"	9'-0"	10'-0"	11'-0"	12'-0"	13'-2"	14'-8"		

### Design Assumptions:

1. The hole locations listed above are valid for floor joists supporting only uniform loads. The total uniform load shall not exceed 130 plf (e.g., 40 psf Live Load and 25 psf Dead Load spaced 24" oc).
2. Hole location is measured from the inside face of bearing to the center of a circular hole, from the closest support.
3. Clear Span has not been verified for these joists and is shown for informational purposes only! Verify that the joist selected will work for the span and loading conditions needed before checking hole location.
4. The maximum hole depth for circular holes is the I-joist Depth less 4", except the maximum hole depth is 6" for 9-1/2" PWI joists, and 8" for 11-7/8" PWI joists.
5. Holes cannot be located in the span where designated "-", without further analysis by a design professional.

### Notes:

1. Holes may be placed anywhere within the depth of the web. A minimum 1/4" clear distance from the flanges is recommended so as not to cut a flange.
2. Round holes up to 1-1/2" diameter may be placed anywhere in the web.
3. Perforated "knockouts" may be neglected when locating web holes.
4. Holes larger than 1-1/2" are not permitted in cantilevers without special engineering.
5. Multiple holes shall have a clear separation along the length of the joist of at least twice the larger dimension of the larger adjacent hole, or a minimum of 12" center-to-center, whichever is greater.
6. Multiple holes may be spaced closer provided they fit within the boundary of an acceptable larger hole. Example: two 3" round holes aligned parallel to the joist length may be spaced 2" apart (clear distance) provided that a 3" high by 8" long rectangle or an 8" diameter round hole are acceptable for the joist depth at that location and completely encompass the holes.
7. For conditions not covered in this table, use the Exacte by PWT software or contact your local PWT distributor for more information.

# Web Hole Specifications

## Rectangular Holes

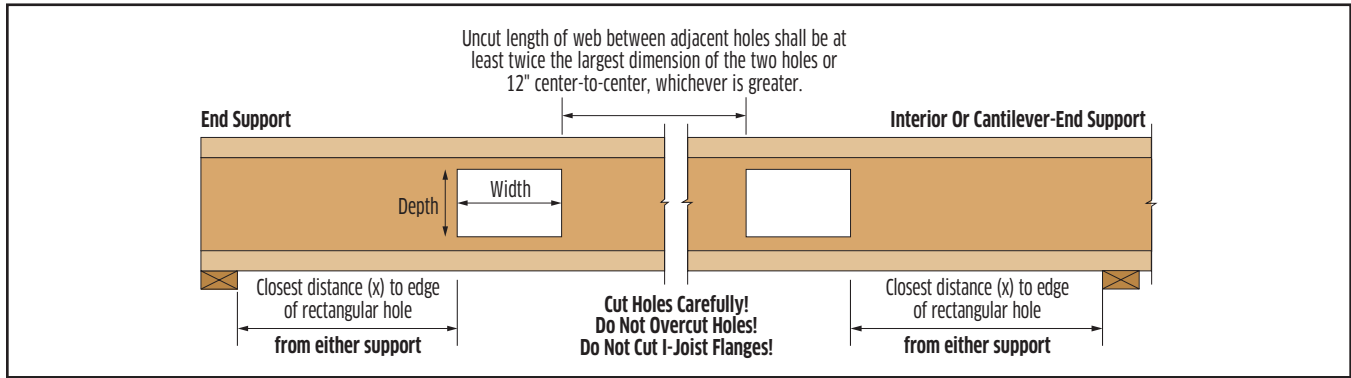

### Table Usage:

1. Select the required series and depth.
2. Determine the support condition for the nearest bearing: end support or interior support (including cantilever-end supports).
3. Select the row corresponding to the required Clear Span. For spans between those listed, use the next largest value.
4. Select the column corresponding to the required Clear Span. For dimensions between those listed, use the next largest value.
5. The intersection of the Clear Span row and Hole Dimension column gives the minimum distance from the inside face of bearing to the nearest edge of a square or rectangular hole.
6. Double check the distance to the other support, using the appropriate support condition.

Series	Depth	Clear Span (ft)	Distance from End Support					Distance from Interior or Cantilever-End Support						
			Maximum Hole Dimension: Depth or Width					Maximum Hole Dimension: Depth or Width						
			2"	4"	6"	8"	10"	12"	2"	4"	6"	8"	10"	12"
PWI 18S, LPI 18	9-1/2"	6	1'-0"	1'-0"	1'-0"	1'-0"	1'-2"	1'-7"	1'-0"	1'-0"	1'-3"	1'-6"	1'-10"	2'-2"
		10	1'-0"	1'-4"	2'-10"	3'-3"	3'-9"	4'-3"	1'-3"	2'-6"	3'-9"	4'-0"	4'-5"	-
		14	2'-2"	3'-8"	5'-5"	5'-11"	6'-6"	-	3'-9"	5'-0"	6'-4"	-	-	-
	11-7/8"	18	4'-7"	6'-3"	8'-2"	-	-	-	6'-3"	7'-6"	-	-	-	-
		10	1'-0"	1'-0"	2'-2"	3'-6"	4'-0"	-	1'-1"	2'-2"	3'-2"	4'-2"	-	-
		14	2'-0"	3'-3"	4'-8"	6'-3"	-	-	3'-7"	4'-8"	5'-8"	-	-	-
PWI 20S, LPI 20Plus & PWI 32S, LPI 32Plus	9-1/2"	18	4'-4"	5'-9"	7'-3"	-	-	6'-1"	7'-2"	8'-5"	-	-	-	
		22	6'-10"	8'-4"	10'-1"	-	-	8'-7"	9'-9"	-	-	-	-	
		6	1'-0"	1'-0"	1'-0"	1'-0"	1'-0"	1'-5"	1'-0"	1'-0"	1'-0"	1'-3"	1'-8"	2'-0"
	11-7/8"	10	1'-0"	1'-0"	2'-6"	2'-11"	3'-5"	3'-11"	1'-0"	1'-0"	3'-5"	3'-9"	4'-2"	-
		14	1'-5"	2'-9"	4'-2"	5'-11"	6'-6"	-	3'-1"	4'-3"	5'-4"	-	-	-
		18	3'-8"	5'-2"	6'-9"	8'-8"	-	-	5'-7"	6'-9"	7'-11"	-	-	-
14"	22	6'-1"	7'-9"	9'-6"	-	-	-	8'-1"	9'-3"	-	-	-	-	
	14	1'-0"	1'-0"	1'-0"	2'-8"	4'-11"	5'-9"	1'-0"	1'-0"	2'-6"	4'-2"	5'-10"	-	
	18	1'-0"	1'-0"	2'-11"	5'-1"	7'-7"	8'-6"	1'-7"	3'-3"	5'-0"	6'-8"	-	-	
16"	22	1'-4"	3'-3"	5'-4"	7'-8"	10'-5"	-	4'-1"	5'-9"	7'-6"	9'-2"	-	-	
	26	3'-6"	5'-7"	7'-10"	10'-4"	-	-	6'-7"	8'-3"	10'-0"	12'-0"	-	-	
	18	1'-0"	1'-0"	2'-5"	4'-4"	6'-5"	-	1'-5"	3'-0"	4'-6"	6'-1"	7'-8"	-	
PWI 42S, LPI 42Plus	11-7/8"	22	1'-2"	2'-11"	4'-9"	6'-10"	9'-2"	-	3'-11"	5'-6"	7'-0"	8'-7"	10'-6"	-
		26	3'-4"	5'-2"	7'-2"	9'-5"	11'-11"	-	6'-5"	8'-0"	9'-6"	11'-1"	-	
		30	5'-8"	7'-7"	9'-9"	12'-1"	-	-	8'-11"	10'-6"	12'-0"	14'-0"	-	
	14"	10	1'-0"	1'-0"	1'-0"	3'-3"	3'-9"	4'-3"	1'-0"	1'-9"	2'-10"	4'-0"	4'-5"	-
		14	1'-5"	2'-9"	4'-2"	5'-11"	6'-6"	-	3'-1"	4'-3"	5'-4"	-	-	-
		18	3'-8"	5'-2"	6'-9"	8'-8"	-	-	5'-7"	6'-9"	7'-11"	-	-	-
16"	22	6'-1"	7'-9"	9'-6"	-	-	-	8'-1"	9'-3"	-	-	-	-	
	14	1'-0"	1'-0"	1'-0"	2'-8"	4'-11"	5'-9"	1'-0"	1'-0"	2'-6"	4'-2"	5'-10"	-	
	18	1'-0"	1'-0"	2'-11"	5'-1"	7'-7"	8'-6"	1'-7"	3'-3"	5'-0"	6'-8"	-	-	
16"	22	1'-4"	3'-3"	5'-4"	7'-8"	10'-5"	-	4'-1"	5'-9"	7'-6"	9'-2"	-	-	
	26	3'-6"	5'-7"	7'-10"	10'-4"	-	-	6'-7"	8'-3"	10'-0"	12'-0"	-	-	
	30	5'-8"	7'-7"	9'-9"	12'-1"	-	-	8'-11"	10'-6"	12'-0"	14'-0"	-	-	

### Design Assumptions:

1. The hole locations listed above are valid for floor joists supporting only uniform loads. The total uniform load shall not exceed 130 plf (e.g., 40 psf Live Load and 25 psf Dead Load spaced 24" oc).
2. Hole location is measured from the inside face of bearing to the nearest edge of a rectangular hole, from the closest support.
3. Clear Span has not been verified for these joists and is shown for informational purposes only! Verify that the joist selected will work for the span and loading conditions needed before checking hole location.
4. The maximum hole depth for rectangular holes is the I-joist Depth less 4", except the maximum hole depth is 6" for 9-1/2" PWI joists, and 8" for 11-7/8" PWI Joists. Where the Maximum Hole Dimension exceeds the hole depth, the dimension refers to hole width and the depth of the hole is assumed to be the maximum for that joist depth. The maximum hole width is 18", regardless of I-joist Depth.
5. Holes cannot be located in the span where designated "-", without further analysis by a design professional.

### Notes:

1. Holes may be placed anywhere within the depth of the web. A minimum 1/4" clear distance from the flanges is recommended so as not to cut a flange.
2. Round holes up to 1-1/2" diameter may be placed anywhere in the web.
3. Perforated "knockouts" may be neglected when locating web holes.
4. Holes larger than 1-1/2" are not permitted in cantilevers without special engineering.
5. Multiple holes shall have a clear separation along the length of the joist of at least twice the larger dimension of the larger adjacent hole, or a minimum of 12" center-to-center, whichever is greater.
6. Multiple holes may be spaced closer provided they fit within the boundary of an acceptable larger hole. Example: two 3" round holes aligned parallel to the joist length may be spaced 2" apart (clear distance) provided that a 3" high by 8" long rectangle or an 8" diameter round hole are acceptable for the joist depth at that location and completely encompass the holes.
7. For conditions not covered in this table, use the Exacte by PWT software or contact your local PWT distributor for more information.

# Floor Details

<p><b>A1 RIM BOARD</b></p> <p>Fasten rim board to each floor I-joist using one 8d nail per flange</p> <p>Same depth as I-joist</p> <p>8d nails at 6" oc toe-nailed from outside of building</p>	<p><b>A2 RIM JOIST</b></p> <p>Note: Do not use PWI joists with flanges wider than 2-1/2" as rim joists.</p> <p>Rim joists with flanges wider than 1-3/4" require a minimum 2 x 6 plate</p> <p>Fasten rim joist to each floor I-joist with one 10d nail into the end of each flange.</p> <p>Use 16d box nails for rim joists with flanges wider than 1-3/4"</p> <p>8d nails at 6" oc (when used for shear transfer, nail to bearing plate with same nailing schedule for decking)</p>	<p><b>A3 BLOCKING AT EXTERIOR WALL</b></p> <p>8d nails at 6" oc (when used for shear transfer, nail to bearing plate with same nailing schedule for decking)</p> <p>OSB or PWT LVL Rim may be substituted for PWI blocking</p>
<p><b>A4 SOLID BLOCKING AT EXTERIOR WALL</b></p> <p>OSB or PWT LVL Rim as blocking</p> <p>Same depth as I-joist</p> <p>8d nails at 6" oc toe-nailed from outside of building</p>	<p><b>A5 JOIST SUPPORT NAILING</b></p> <p>Secure I-joist to plate with two 8d nails. Drive one nail from each side of I-joist, angled inward</p> <p>Blocking is required when joists end at support. Blocking may be required at interior supports by project designer or by code for seismic design</p> <p>Place nail 1-1/2" min. from end of I-joist. If nails are close to edge of plate, drive at an angle to reduce splitting</p>	<p><b>B1 WEB STIFFENERS AT INTERIOR SUPPORT (WHEN REQUIRED)</b></p> <p>Verify stiffener requirements (see Web Stiffener detail)</p>
<p><b>B2 SQUASH BLOCKS</b></p> <p>Blocking panels may be required with shear wall</p> <p>Use double squash blocks as specified. Squash blocks shall be cut 1/16" taller than I-joist. 2 x 4 min.</p> <p>Stagger 8d nails to avoid splitting</p> <p>Bearing wall aligned under wall above</p> <p>Toe-nail 8d box nail to plate</p>	<p><b>B3 BLOCKING AT INTERIOR SUPPORT</b></p> <p>Blocking is not required if no wall above unless I-joists end at support. Blocking may be required at interior supports by project designer or by code for seismic design</p> <p>OSB or PWT LVL Rim may be substituted for PWI blocking</p> <p>Bearing wall aligned under wall above</p>	<p><b>NON-STACKING WALLS</b></p> <p>OSB or PWT LVL Rim may be substituted for PWI blocking</p> <p>PWT I-joists shall be designed to carry all applied loads including walls from above that do not stack directly over the I-joist support.</p>
<p><b>D2 POST LOADS</b></p> <p>Squash blocks (cripples) required under all post loads</p>	<p><b>E1 STAIR STRINGER</b></p> <p>Web filler (as backer block) minimum 12" long</p> <p>Filler block(s) same length as web filler, minimum</p> <p>Approved connection (by others)</p> <p>See I-joist Header Cross-Section for connection information of the filler and backer blocks</p> <p>See I-joist Filler Schedule for filler block and web filler sizes</p>	<p><b>E2 HANGER DETAIL</b></p> <p>Applied loads at end of I-joist must be supported directly by the girder, or by a ledger or blocking fastened to the girder.</p> <p>Be sure to check web filler requirements for hangers</p> <p>Verify capacity and fastening requirements of hangers and connectors</p>



# Floor Details

## E3 I-JOIST HEADER

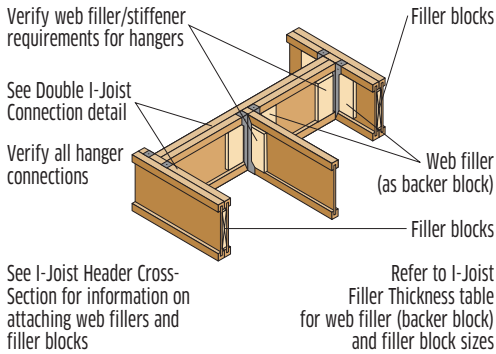

## E4 I-JOIST HEADER CROSS SECTION

**Filler Blocks:** Fasten I-Joists together with filler blocks between the PWI webs:

- Filler blocks must be installed at any load that is not applied to the top of the member and equally to all plies. See Detail E5 for installation instructions.
- For joists supporting only top loads that are equally applied to both plies, filler blocks can be omitted.

**Backer Blocks:** Minimum 12" long backer blocks must be installed at all hangers and all concentrated loads that are not equally applied to each ply, center backer block on load.

- For a single I-joist header install backer blocks to both sides of the web.
- Backer blocks may be omitted for top-mount hangers supporting only downward loads not exceeding 250 lbs.
- Install backer blocks tight to top flange for top-mount hangers or top concentrated loads. Install tight to bottom flange for face-mount hangers.
- Attach using 10 nails (0.131" x 3-1/4" (min.), clinch where possible) spaced to avoid splitting, with half the nails to each

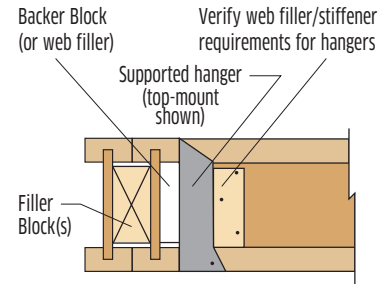

## E5 DOUBLE I-JOIST CONNECTION

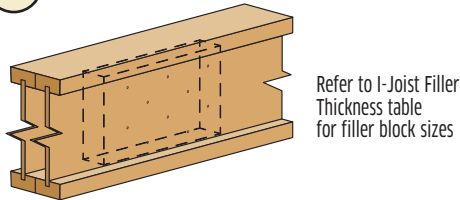

Filler blocks must be:

- Long enough not to split when nailed (12" min.)
- Located at each support
- Under all concentrated loads that are not equally applied to each ply
- Centered behind each hanger
- At 24" oc max. under all uniform loads that are not equally applied to each ply
- Installed tight to top flange at top-mount hangers and top concentrated loads.
- Installed tight to bottom flange at supports and facemount hangers.

Floor sheathing to be glued and nailed to flanges of both plies

Attach using ten (10) 0.131" x 3-1/4" nails (min.):

- Joists ≤ 2-1/2" thick: from either side, total of 10 nails
  - Joists > 2-1/2" thick: from each side, total of 20 nails
- Stagger rows, clinch where possible, and spaced to avoid splitting.

### Filler and Backer Blocks:

- Refer to the I-Joist Filler Thickness table for the correct filler and backer block thickness.
- Filler and backer blocks shall consist of APA Rated wood structural panel (OSB or plywood), 2 x lumber (SPF or better), or PWT LVL or OSB Rim Board.
- Filler and backer blocks for members that are top-loaded only, or at hangers that do not require nailing into the web, shall be: at least 5-1/2" deep for I-joists up to 11-7/8" deep and at least 7-1/4" deep for I-joists deeper than 11-7/8". Otherwise, filler blocks shall fit the clear distance between flanges with a gap of at least 1/8", but not more than 1".
- For double PWIs that are not top loaded or have loads that are not applied equally to both plies, the max unfactored loads for standard duration: Concentrated Load = 1200 lbs., Uniform Load = 520 plf. Loads may be increased with more nails and adjusted for other load durations.

Contact the project's design professional or a PWT distributor if these conditions are not met.

### Filler Block Depth Example:

Multiple filler blocks may be stacked vertically to achieve the filler depth for a 14" deep I-joist (min. req. is 14" - 3" - 1"=10"). One row of nails must be in each filler.

### Backer Block Length Example:

Two pieces, example 2 x 8 (min.) lumber, that are cut to the proper height may be set vertically side-by-side to achieve the required minimum 12" length. side of the center of the supported hanger.

- Face mount hanger nails must be min. 3" long per manufacturer's specifications.

## NON LOAD-BEARING CANTILEVER

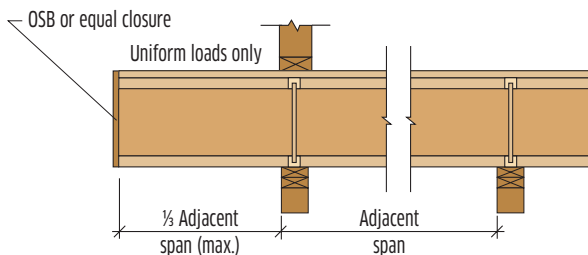

## BEVEL CUT/FIRE CUT

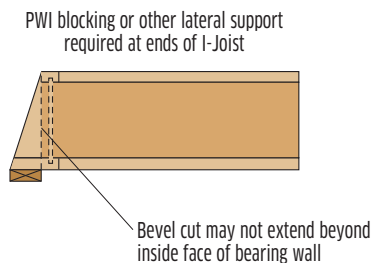

## I-JOIST FILLER THICKNESS

Span (ft)	Filler Block	Web Filler/ Backer Block
PWI 18S, LPI 18, PWI 20S, LPI 20Plus, PWI 32S, LPI 32Plus	2-1/8"	1"
PWI 42S, LPI 42Plus	3"	1-1/2"

### Notes:

1. Backer blocks and filler blocks shall consist of APA Rated wood structural panel (OSB or plywood), or 2x lumber (SPF or better).
2. OSB or PWT LVL Rim may also be used.
3. Refer to the Notes for the I-Joist Header Cross-Section above for details on the required height and length, and nailing of the backer blocks and filler blocks.

### General Notes:

1. Some wind or seismic loads may require different or additional details and connections.
2. Verify building code requirements for suitability of details shown.
3. Refer to page 4 for bearing length requirements.
4. Refer to page 20 for Flange Face Nailing Schedule for PWI rim joist or blocking panel nailing.
5. Lateral support shall be considered for bottom flange when there is no sheathing on underside.
6. Verify capacity and fastening requirements of hangers and connectors.
7. Squash block capacity designed by others.

# Roof Details

<p><b>J1 RAFTER CONNECTION</b></p> <p>Simpson® LSTA24, MiTek® LSTI-22 strap or equal</p> <p>Beveled plate</p> <p>PWI blocking<sup>5</sup></p> <p>Support beam or wall</p>	<p><b>J2 RAFTER CONNECTION WITH FITTED OSB GUSSET</b></p> <p>23/32" x 2'-0" OSB with 12-8d nails each side min. 1/8" gap at top</p> <p>Beveled plate</p> <p>PWI blocking<sup>5</sup></p> <p>Support beam or wall</p>	<p><b>J3 RIDGE RAFTER CONNECTION</b></p> <p>Web filler required each side</p> <p>Simpson LSTA24, MiTek LSTI-22 strap (or equal) for pitch over 7:12</p> <p>Structural beam</p> <p>Simpson LSSU, MiTek LSSH (or equal) hanger</p>
<p><b>J4 HEADER CONNECTION</b></p> <p>Header</p> <p>Simpson LSTA24, MiTek LSTI-22 strap (or equal) for pitch over 7:12</p> <p>Web filler required each side</p> <p>Simpson LSSU, MiTek LSSH (or equal) hanger</p>	<p><b>H1 BIRD'S MOUTH (LOWER BEARING ONLY)</b></p> <p>Cut to fit tight to wall plate</p> <p>Don't cut beyond inside face of bearing</p> <p>PWI blocking<sup>5</sup></p> <p>2'-0" max.</p> <p>Beveled web stiffeners required both sides</p>	<p><b>H2 BEVELED PLATE</b></p> <p>PWI blocking<sup>5</sup></p> <p>2x beveled plate</p> <p>Simpson VPA, MiTek TMP (or equal) connector may be substituted for beveled plate</p>
<p><b>H3 FLAT SOFFIT (FASCIA SUPPORT)</b></p> <p>PWI blocking<sup>5</sup></p> <p>8d nails at 6" oc clinched</p> <p>Beveled plate</p> <p>2 x 4 cut to fit</p> <p>2'-0" max.</p>	<p><b>H4 OVERHANG</b></p> <p>8d nails at 6" oc staggered and clinched</p> <p>PWI blocking<sup>5</sup></p> <p>2 x 4 filler</p> <p>2 x 4 cut to fit both sides</p> <p>2'-0" max.</p> <p>4'-0" min.</p>	<p><b>H5 OVERHANG</b></p> <p>8d nails at 6" oc 1" from edge</p> <p>PWI blocking<sup>5</sup></p> <p>2 x 4 cut to fit</p> <p>Beveled plate</p> <p>Web fillers required both sides of I-Joist</p> <p>8d box toe-nail to plate</p> <p>2'-0" max.</p> <p>4'-0" min.</p>
<p><b>K1 ROOF OPENING HANGER CONNECTIONS</b></p> <p>Web stiffener required (see Web Stiffener details)</p> <p>Web filler</p> <p>Filler on back side</p> <p>Install header plumb</p> <p>Filler block</p> <p>Web filler</p>	<p><b>K2 OUTRIGGER</b></p> <p>8d nails staggered at 6" oc</p> <p>Maximum overhang same as rafter spacing (2'-0" max.)</p> <p>2 x 4 filler</p> <p>Ladder</p> <p>Gable end</p>	<p><b>Notes:</b></p> <ol style="list-style-type: none"> <li>1. Minimum pitch: 1/4" per foot (1/4:12). Maximum pitch: 12" per foot (12:12).</li> <li>2. Verify capacity and fastening requirements of hangers and connectors.</li> <li>3. Some wind or seismic loads may require different or additional details and connections. Uplift anchors may be required.</li> <li>4. 4" diameter hole(s) may be cut in blocking for ventilation.</li> <li>5. Lateral resistance shall be provided. Other methods of restraint, such as full depth OSB Rim Board, PWT LVL or metal X-bracing may be substituted for the PWI blocking shown.</li> </ol>

# Framing Connectors

## General Notes:

1. The following tables provide a list of the more common hangers and connectors for use with PWT™ I-Joists.
2. Refer to the manufacturer's connector guide for a complete list of hangers and to verify the suitability of a hanger or connector for a particular application.
3. Follow all connector manufacturers' installation guidelines.

## SIMPSON STRONG-TIE®

Series	Depth	Top-Mount		Face-Mount		45° Skewed	Field Slope & Skew	Variable Pitch Seat
		Single	Double	Single	Double	Single	Single	Single
2-1/2" Flange PWI 18S, LPI 18 PWI 20S, LPI 20Plus PWI 32S, LPI 32Plus	9-1/2"	ITS2.56/9.5	MIT39.5-2	IUS2.56/9.5	MIU5.12/9	SUR/L2.56/9	LSSUH310 *	VPA3
	11-7/8"	ITS2.56/11.88	MIT311.88-2	IUS2.56/11.88	MIU5.12/12	SUR/L2.56/11	LSSUH310 *	VPA3
2-1/2" Flange PWI 20S, LPI 20Plus PWI 32S, LPI 32Plus	14"	ITS2.56/14	MIT314-2	IUS2.56/14	MIU5.12/14	SUR/L2.56/14	LSSUH310 *	VPA3
	16"	ITS2.56/16	MIT5.12/16	IUS2.56/16	MIU5.12/16	SUR/L2.56/14 *	**	VPA3
3-1/2" Flange PWI 42S, LPI 42Plus	11-7/8"	ITS3.56/11.88	B7.12/11.88 *	IUS3.56/11.88	HU412-2 *	SUR/L410 *	LSSU410 *	VPA4
	14"	ITS3.56/14	B7.12/14 *	IUS3.56/14	HU414-2 *	SUR/L414 *	LSSU410 *	VPA4
	16"	ITS3.56/16	B7.12/16 *	IUS3.56/16	HU414-2 *	SUR/L414 *	**	VPA4

\* Web filler required for proper installation of hanger.

\*\* Refer to Simpson Strong-Tie "Wood Construction Connectors" catalog for hanger selection.

## MITEK® STRUCTURAL CONNECTORS



Series	Depth	Top-Mount		Face-Mount		45° Skewed	Field Slope & Skew	Variable Pitch Seat
		Single	Double	Single	Double	Single	Single	Single
2-1/2" Flange PWI 18S, LPI 18 PWI 20S, LPI 20Plus PWI 32S, LPI 32Plus	9-1/2"	TFL2595	TH025950-2 *	THFI2595	IHF25925-2 *	SKH2520L/R *	LSSH25 *	TMP25 or TMPH25 *
	11-7/8"	TFL25118	TH025118-2 *	THFI25118	IHF25112-2 *	SKH2520L/R *	LSSH25 *	TMP25 or TMPH25 *
2-1/2" Flange PWI 20S, LPI 20Plus PWI 32S, LPI 32Plus	14"	TFL2514	TH025140-2 *	THFI2514	THF25140-2 *	SKH2524L/R *	LSSH25 *	TMP25 or TMPH25 *
	16"	TFL2516	TH025160-2 *	IHFL2516	THF25160-2 *	SKH2524L/R *	LSSH25 * †	TMP25 or TMPH25 *
3-1/2" Flange PWI 42S, LPI 42Plus	11-7/8"	TH035118	BPH71118 *	IHFL35112	HD7120 *	HD410_SK45L/R_BV ***	LSSH35 *	TMP4 or TMPH4 *
	14"	TH035140	BPH7114 *	IHFL3514	HD7140 *	HD414_SK45L/R_BV ***	LSSH35 *	TMP4 or TMPH4 *
	16"	TH035160	BPH7116 *	IHFL3516	HD7160 *	HD414_SK45L/R_BV ***	LSSH35 * †	TMP4 or TMPH4 *

\* Web filler required for proper installation of hanger.

\*\* Miter cut required on end of joist.

† Hanger height is less than 60% of the joist depth. Supplemental lateral support of the top flange is required. Refer to MiTek's installation instructions.

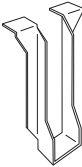
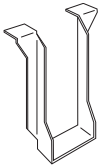
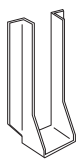
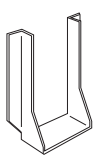
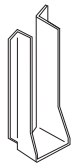
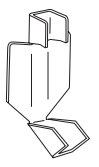
1. Use TMP seats for joist pitch of 1:12 to 6:12. Use TMPH for joist pitch of 6:12 and greater.

Top-Mount		Face-Mount		45° Skewed	Field Slope & Skew	Variable Pitch Seat
						

# Web Stiffeners

## WEB STIFFENER DETAILS

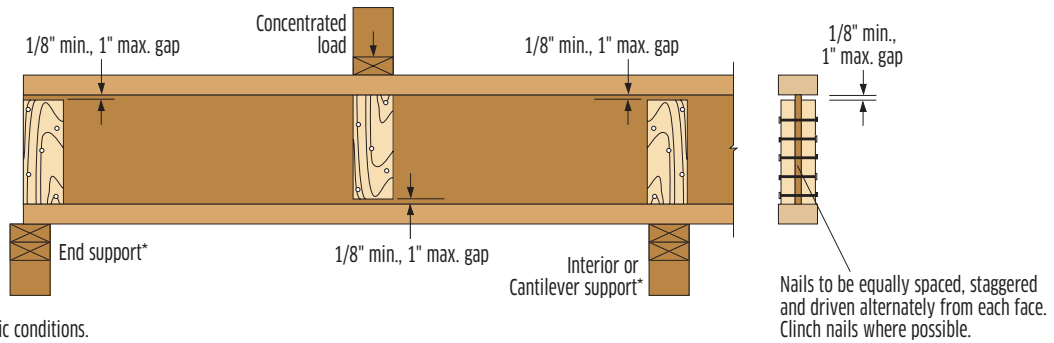

\*Refer to framing plan for specific conditions.

### Notes:

1. Web stiffeners shall be installed in pairs - one to each side of the web. Web stiffeners are always required for the "Bird's Mouth" roof joist bearing detail.
2. Web stiffeners shall be cut to fit between the flanges of the PWT I-Joist, leaving a minimum 1/8" gap (1" maximum). At bearing locations, the stiffeners shall be installed tight to the bottom flange. At locations of concentrated loads, the stiffeners shall be installed tight to the top flange.
3. Web stiffeners shall be cut from APA Rated OSB (or equal) or from PWT LVL or OSB Rim Board. 2x lumber is permissible. Do NOT use 1x lumber as it tends to split. Do NOT build up the required stiffener thickness from multiple pieces.
4. Web stiffeners shall be the same width as the bearing surface, with a minimum of 3-1/2".
5. See Web Stiffener Requirements for minimum stiffener thickness, maximum stiffener height and required nailing.

## WEB STIFFENER REQUIREMENTS

Series	Depth	Minimum Thickness	Maximum Height	Nail Size*	Nail Quantity
PWI 18S, LPI 18 PWI 20S, LPI 20Plus PWI 32S, LPI 32Plus	9-1/2"	23/32"	6-3/8"	8d (2-1/2")	3
	11-7/8"	23/32"	8-3/4"	8d (2-1/2")	3
	14"	23/32"	10-7/8"	8d (2-1/2")	3
	16"	23/32"	12-7/8"	8d (2-1/2")	3
PWI 42S, LPI 42Plus	11-7/8"	1-1/2"	8-3/4"	10d (3")	3
	14"	1-1/2"	10-7/8"	10d (3")	3
	16"	1-1/2"	12-7/8"	10d (3")	3

\*Nails may be Box or Common.

# Rim and Blocking

## RIM & BLOCKING CAPACITY

Series	Depth	Uniform Vertical Load Capacity (plf)
PWI 18S, LPI 18 PWI 20S, LPI 20Plus	9-1/2"	1900
	11-7/8"	1760
PWI 20S, LPI 20Plus	14"	1600
	16"	1500
PWI 32S, LPI 32Plus	9-1/2"	2200
	11-7/8"	2200
	14"	1600
	16"	1500
PWI 42S, LPI 42Plus	11-7/8"	2200
	14"	2000
	16"	2000

### Notes:

1. Uniform Vertical Load Capacity shall not be adjusted for load duration.
2. Concentrated vertical loads require the addition of squash blocks. Do not use PWI rim or blocking to support concentrated vertical loads.
3. Lateral load capacity for all series above is 200 plf but may be limited by the connection details used. Do not exceed the Flange Face Nailing requirements at right.

# Nailing

## FLANGE FACE NAILING

Series	Nail Size and Type	Minimum Nail Distance	
		oc Spacing	End
PWI 18S, LPI 18	8d (2-1/2") Box or Common	2"	1"
	10d (3") or 12d (3-1/4") Box	2"	1"
PWI 20S, LPI 20Plus	10d (3") or 12d (3-1/4") Common	3"	1-1/2"
	16d Sinker (3-1/4")	3"	1-1/2"
PWI 32S, LPI 32Plus	16d Sinker (3-1/4")	3"	1-1/2"
PWI 42S, LPI 42Plus	16d (3-1/2") Box or Common	4"	1-1/2"

### Notes:

1. Use only 10d box or 8d nails when securing an PWI floor or roof joist to its supports.

# Rim Board

## RIM BOARD CAPACITIES

Material	Grade	Thickness	Vertical Load Capacity <sup>1</sup>			Lateral <sup>4,5,6</sup> Load Capacity (plf)
			Uniform <sup>2</sup> (plf)		Concentrated <sup>3</sup> (lbs)	
			d ≤ 16"	16" < d ≤ 24"	d ≤ 24"	
OSB	APA C2/Rim Board <sup>7</sup>	1"	3300	1650	3500	180
	APA C1/Rim Board <sup>7</sup>	1-1/8"	4400	3000	3500	180

### Notes:

- The Vertical Load Capacity shall not be increased for short-term load duration.
- The Uniform Vertical Load Capacity is based on the capacity of the rim board and may need to be reduced based on the bearing capacity of the supporting wall plate or the attached floor sheathing.  
**Example:** The allowable bearing stress for commodity floor sheathing is 360 psi so the bearing capacity of a 1-1/4" x 16" deep rim board would be limited to 5400 plf (360 psi x 1-1/4" x 12).
- The Concentrated Vertical Load Capacity is assumed to be applied through a minimum 4-1/2" bearing length (3-stud post).
- The Lateral Load Capacity is based on a short-term load duration and shall not be increased.
- The Lateral Load Capacity is based on the connections specified in the Installation details on the previous page.
- Additional framing connectors fastened to the face of the rim board may be used to increase lateral capacity for wind and seismic design.
- The APA C1 and C2 grades in product standard ANSI/APA PRR 410-2011 are equivalent to the rim board grade in product standard APA PRR-401.

## ALLOWABLE UNIFORM LOADS (PLF) FOR RIM BOARD HEADERS: MAXIMUM 4' CLEAR SPAN

Material	Thickness	Rim Board Depth			
		9-1/2"	11-7/8"	2-Ply 14"	2-Ply 16"
OSB	1"	330 (1-1/2")	480 (3")	1280 (3")	1670 (4-1/2")
	1-1/8"	370 (1-1/2")	540 (3")	1440 (3")	1880 (4-1/2")

### Notes:

- This table is for preliminary design for uniform gravity loads only. Final design should include a complete analysis of all loads and connections.
- The allowable loads are for a maximum 4' clear span with minimum bearings for each end (listed in parentheses) based on the bearing capacity of the rim board. For headers bearing on wood plates, the bearing length may need to be increased based on the ratio of the bearing capacity of the rim board divided by the bearing capacity of the plate species.
- Normal load duration is assumed and shall be adjusted according to code.
- Depths greater than 11-7/8" shall be used with a minimum of two plies, as shown. Depths of 11-7/8" and less may be used as a two-ply header by multiplying the allowable loads by two.
- Multiple-ply headers shall be toe-nailed to the plate from both faces. Fasten the floor sheathing to the top of each ply to provide proper lateral support for each ply.
- For multiple-ply headers supporting top-loads only, fasten plies together with minimum 8d box nails (2-1/2" x 0.113") at a maximum spacing of 12" oc. Use 2 rows of nails for 9-1/2" and 11-7/8". Use 3 rows for depths 14" and greater. Clinch the nails where possible. For side-loaded multiple-ply headers, refer to the Connection Capacity For Side-Loaded 2-Ply Rim Board Headers table below for the required nailing and the allowable side load that can be applied.
- The designer shall verify proper bearing for the header.
- Joints in the rim are not allowed over openings and must be located at least 12" from any opening.
- Refer to the "APA Performance Rated Rim Boards" (Form No. W345) for additional information including allowable loads for smaller openings.

## CONNECTION CAPACITY FOR SIDE-LOADED 2-PLY RIM BOARD HEADERS (PLF)

Material	Thickness	Minimum Nail Size	3 Rows of Nails at 6" oc	4 Rows of Nails at 6" oc	5 Rows of Nails at 6" oc	6 Rows of Nails at 6" oc
OSB	1" & 1-1/8"	8d (2-1/2" x 0.113")	768	1024	1280	1536

### Notes:

- This table represents the uniform side-load capacity of the connection for a 2-ply header. The total applied uniform load, including top-load and side-load, shall not exceed the allowable uniform load capacity of the header as tabulated above.
- The tabulated side-load capacity is for normal load duration and shall be adjusted according to code.
- Use 3 rows of nails for 9-1/2" and 11-7/8"; 4 rows for 14" and 16"; 5 rows for 18" and 20"; 6 rows for 24" deep rim board. Clinch the nails where possible.
- Headers consisting of more than 2 plies, alternate fastening or higher side loads are possible but require proper design of the connection.

## INSTALLATION

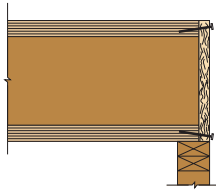
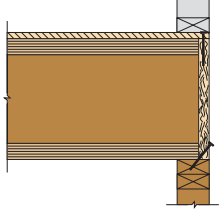
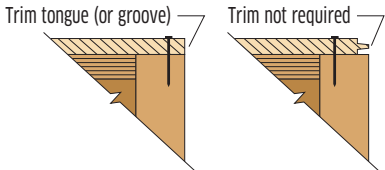
<p><b>Rim-to-Joist Connection</b></p>  <p>Nail rim to I-joist with one 8d (box or common) or 10d box nail into each flange.</p>	<p><b>Deck-to-Rim and Rim-to-Plate Connections<sup>1</sup></b></p> <ul style="list-style-type: none"> <li>Nail floor sheathing to rim board with 8d nails at 6" oc.</li> <li>Nail wall plate through floor sheathing into rim per code.</li> <li>Toe-nail rim board to wall plate with 8d nails at 6" oc.</li> </ul>  <p>See T&amp;G Trim Requirements detail and table.</p>	<p><b>T&amp;G Trim Requirements<sup>2</sup></b></p> <p>See T&amp;G Trim Requirements table below for when to trim tongue or groove.</p>  <p>Trim tongue (or groove)      Trim not required</p>
--	---	---

### Notes:

- Additional framing connectors to the face of the rim board may be used to increase lateral capacity for wind and seismic design.
- Trim the tongue or groove of the floor sheathing in accordance with the T&G Trim Requirements table.

## T&G TRIM REQUIREMENTS

Floor Sheathing Thickness	Rim Board Thickness			
	1"	1-1/8"	1-1/4"	> 1-1/4"
≤ 7/8"	Trim	Not Required	Not Required	Not Required
> 7/8"	Trim	Trim	Trim	Not Required

# Warnings



## WARNINGS

The following conditions are NOT permitted!

Do not use visually damaged products without first checking with your local PWT™ distributor or sales office.

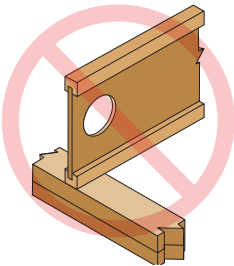
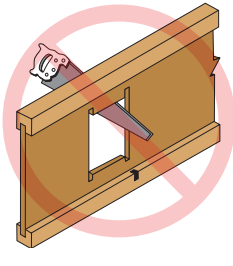
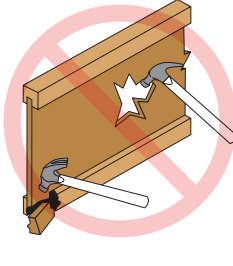
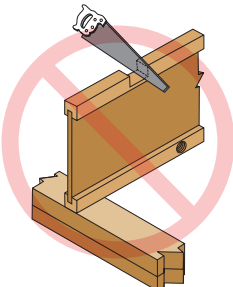
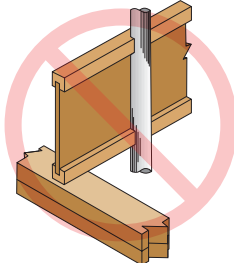
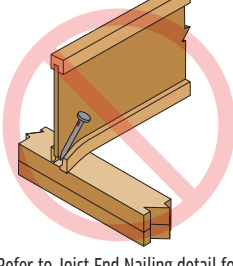
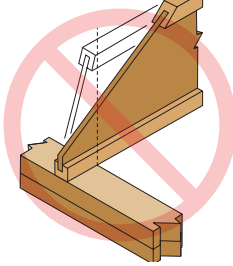
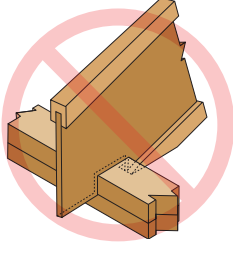
<p>DON'T put holes too close to supports.</p>  <p>Refer to hole chart for correct location.</p>	<p>DON'T overcut hole and damage flange.</p> 	<p>DON'T make hole with hammer unless knock-out is provided.</p>  <p>DON'T hammer on flange and damage joist.</p>	<p>DON'T cut or notch flange.</p>  <p>DON'T drill flange.</p>
<p>DON'T cut flange for pipes.</p> 	<p>DON'T use 16d nails.</p>  <p>Refer to Joist End Nailing detail for correct sizes and locations.</p>	<p>DON'T cut beyond inside edge of bearing.</p> 	<p>DON'T support I-Joist on web.</p> 

# Handling and Storage

## HANDLING AND STORAGE GUIDELINES

- **WARNING:** Failure to follow proper procedures for handling, storage and installation could result in unsatisfactory performance, unsafe structures and possible collapse.
- Keep PWT™ products dry. These products are intended to resist the effects of moisture on structural performance from normal construction delays but are not intended for permanent exposure to the weather.
- Unload products carefully, by lifting. Support the bundles to reduce excessive bowing. Individual products should be handled in a manner which prevents physical damage during measuring, cutting, erection, etc. I-Joists shall be handled vertically and not flatwise.
- Keep products stored in wrapped and strapped bundles, stacked no more than 10' high. Support and separate bundles with 2 x 4 (or larger) stickers spaced no more than 10' apart. Keep stickers in line vertically.
- Product must not be stored in contact with the ground, or have prolonged exposure to the weather.
- Use forklifts and cranes carefully to avoid damaging product.
- Do not use a visually damaged product. Call your local PWT distributor for assistance when damaged products are encountered.
- For satisfactory performance, PWT products must be used under dry, covered and well-ventilated interior conditions in which the equivalent moisture content in lumber is less than 16%.
- For built-up members, all PWT products shall be dry before nailing or bolting to avoid trapping moisture.
- PWT I-Joists and PWT LVL shall not be used for unintended purposes such as ramps and planks.

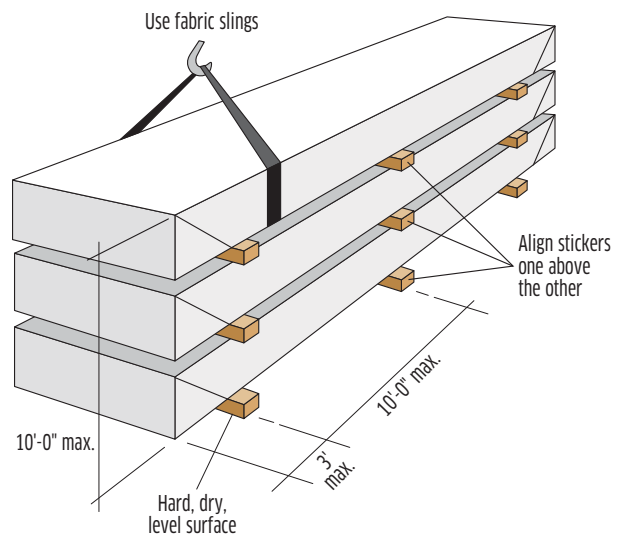



# Software Tools for PWT I-Joist

PWT provides designers and specifiers with the superior information services to complement our products by providing software tools that do the math to ensure the right product is used.

With an easy-to-use graphic user interface for entering data and a single click to get a Pass or Fail, Exacte by PWT provides clear results. Our goal with this program is to provide customers with peace of mind when it comes to making decisions about their projects. We want them to know that they are getting the right product for each application in their building.

At PWT, we understand how important it is for specifiers to get the right product for their project every time. With Exacte by PWT, you can have confidence that your project will turn out exactly how you imagined it!

## Exacte by PWT features:

- User-friendly single-member sizing program with impeccable graphics
- Uses the spans and loads to define if a PWT engineered wood product Passes or Fails. Requires little or no training for architects, engineers, designers, inspectors, builders, and technical support specialists to design and specify individual PWT products
- No charge for Exacte single-member users after registration

**exacte** Client: 414.2023  
Project: Report by: Graphics  
Address: Job Name: Project #:  
Level: Level

**J1 PWT 20S 11.875 - PASSED**

**- PASSED**

1 SFF 19'0" 32'0" 17'0" 3 Hanger (RUS2 56/11.68 (M))

Member Information		Reactions PATTERNED lb (Uplift)	
Type: Joist	Application: Floor	Dir.	Live
Spacing: 16" o.c.	Design Method: ASD	1 Vertical	368 (46)
Moisture Condition: Dry	Building Code: IRC/IRC 2015	2 Vertical	1078 (269)
Deflection LL: 480	Load Sharing: No	3 Vertical	409 (33)
Deflection TL: 240	Deck: Not Checked		
Temperature: Normal - B			
Temperature: Temp +/- 100°F			

Dir.	Cap.	React	D.L. lb	Total	Ld. Case	Ld. Comb.
1 - SFF	3.500"	Vert	39%	73 / 368	440	L, D+L
2 - SFF	3.500"	Vert	58%	272 / 1088	1358	LL, D+L
3 -	3.000"	Vert	50%	92 / 407	459	L, D+L

Analysis	Actual	Location	Allowed	Capacity	Comb.	Case
Neg Moment	-2233 ft-lb	19'0"	3755 ft-lb	0.596 (59%)	D+L	LL
Pos Moment	1614 ft-lb	25'0"	440 (48%)	0.477 (48%)	D+L	LL
Shear	708 lb	19'0"	1485 lb	0.477 (48%)	D+L	LL
LL Defl (inch)	0.279 (L749)	24'0"	0.435 (L480)	0.641 (64%)	L	LL
TL Defl (inch)	0.331 (L620)	24'0"	0.870 (L240)	0.381 (38%)	D+L	LL

**Design Notes**

1. Provide support to prevent lateral movement and rotation at the end bearings. Lateral support may also be required at the interior bearings by the building code.
2. Dead Load Deflection: Instant = 0.027", Long Term = 0.027".
3. Fill all hanger nailing holes.
4. Web Holes: Vertical location may vary and flanges must not be cut.
5. Top flange must be laterally braced at a maximum of 8'8" o.c.
6. Bottom flange must be laterally braced at a maximum of 5'0" o.c.

ID	Load Type	Location	Trib Width	Dead	Live	Snow	Wind	Const.	Comments
1	Uniform	1-4-0	10 PSF	40 PSF	0 PSF	0 PSF	0 PSF	0 PSF	

**Notes**

This document is based on the data provided and is not a warranty. The user is responsible for the accuracy of the data provided. The user is responsible for the accuracy of the data provided. The user is responsible for the accuracy of the data provided.

**Manufacturer Info**

Pacific Woodtech Corp  
1800 Park Lane  
Burlington, WA 98233  
509.737.7070  
www.pacificwoodtech.com  
ICC-ES ESR-1326-04N-PR-1238

Exacte by PWT Version: 10.641 (Build: 2.11.16.641) Powered by Onyxx™ Database: 23040401.276



1850 Park Lane Burlington, WA 98233

TF 888.707.2285

[pwtewp.com](http://pwtewp.com)

For product catalog and complete warranty details or for more information on the full line of PWT products or the nearest distributor, visit [pwtewp.com](http://pwtewp.com).

PWT products are manufactured at different locations in the United States and Canada.



**CAL. PROP 65 WARNING:** Drilling, sawing, sanding or machining wood products can expose you to wood dust, a substance known to the State of California to cause cancer. Avoid inhaling wood dust or use a dust mask or other safeguards for personal protection. For more information go to [www.P65Warnings.ca.gov/wood](http://www.P65Warnings.ca.gov/wood).

© 2024 Pacific Woodtech Corporation. All rights reserved. APA, APA Rated, and APA Product Report are registered trademarks of APA – The Engineered Wood Association. SIMPSON Strong-Tie® is a registered trademark of Simpson Strong-Tie Company, Inc. MiTek® is a registered trademark of MiTek Holdings, Inc. PWT™ is a registered trademark of Pacific Woodtech Corporation. Printed in USA. Specifications (details) subject to change without notice.

NOTE: PWT periodically updates and revises its product information. To verify that this version is current, contact the nearest sales office, visit [pwtewp.com](http://pwtewp.com), or call 888.707.2285.

